



ENGLISH  
DEUTSCH  
FRANÇAIS  
ITALIANO  
ESPAÑOL

## Quick Start Guide

# snom 760

IP Phone

**A**

**Delivery content - Lieferumfang - Contenu de la boîte -  
Contenuto della confezione - En la caja**

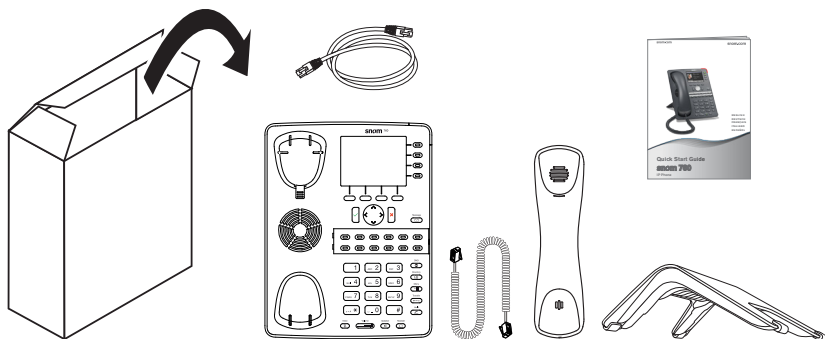
**B**

**Attaching the Footstand - Fuß befestigen  
Attacher le pied - Fissare il supporto - Montar el soporte**

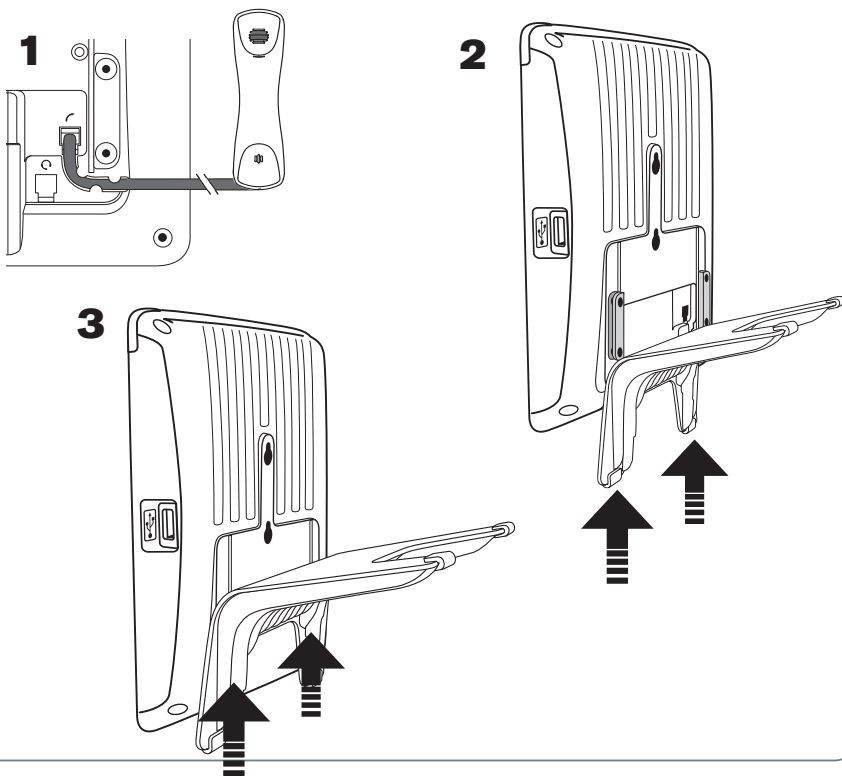
**C**

**Connecting - Anschließen - Connecter - Collegare - Conectar**

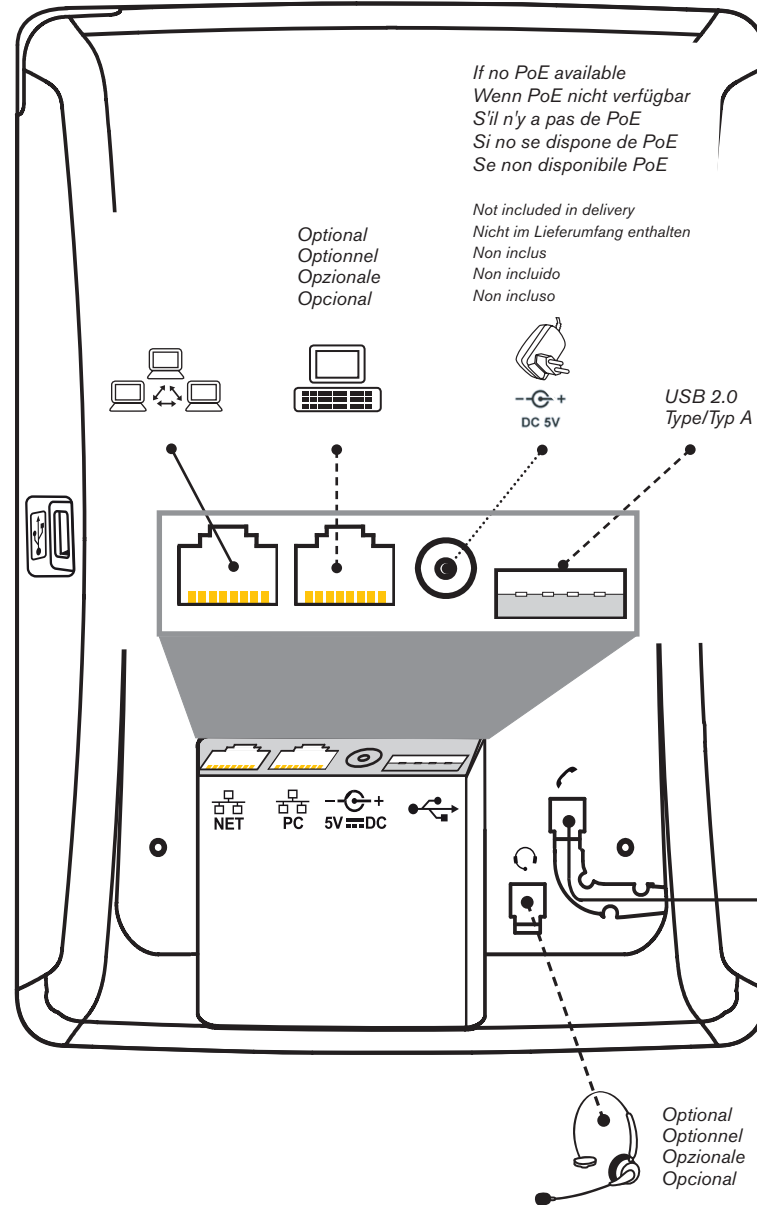

# D

## Wall Mounting - Wandmontage - Fixation murale - Montaje en pared - Montaggio a parete - Montagem na parede

Not included in delivery · Nicht im Lieferumfang enthalten: 2 x   
Non inclus · No incluidos · Non inclusos:

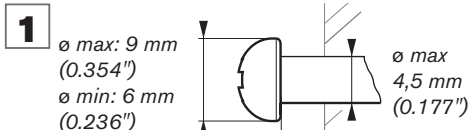

Distance to wall  
Abstand zur Wand  
Distance au mur  
Distanza dalla parete  
Distancia a la pared  
Distância à parede

~ 4 mm (0.157")

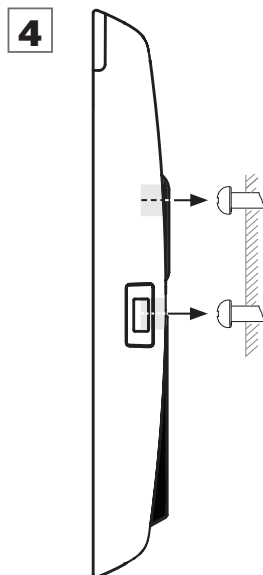
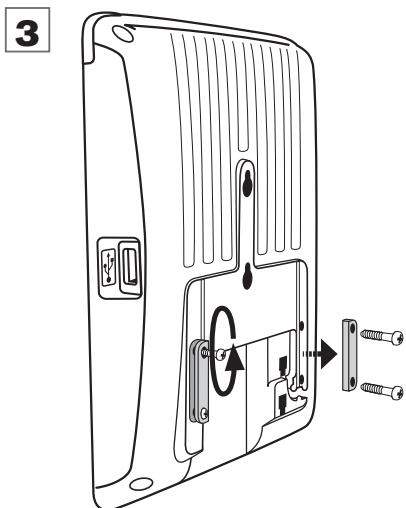
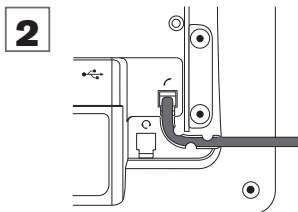
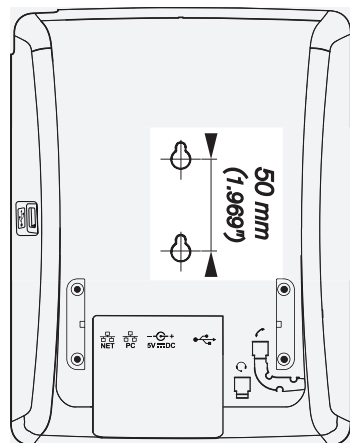

## Table of Contents - Inhaltsverzeichnis Table des matières - Indice - Índice

|  |    |
|--|----|
| <b>ENGLISH</b> .....                                     | 7  |
| <b>DEUTSCH</b> .....                                     | 17 |
| <b>FRANÇAIS</b> .....                                    | 29 |
| <b>ITALIANO</b> .....                                    | 39 |
| <b>ESPAÑOL</b> .....                                     | 49 |
| <br><b>APPENDIX • ANHANG • ANNEXE • APENDICE • ANEXO</b> |    |
| GNU General Public License .....                         | 59 |

## Symbols used in this guide - In dieser Anleitung benutzte Symbole Symboles utilisés dans ce manuel - Simboli utilizzati in questa manuale Símbolos usados en este manual

Press the key:  
Drücken Sie auf die Taste:  
Appuyez sur la touche:  
Premere il tasto:  
Pulse la tecla:

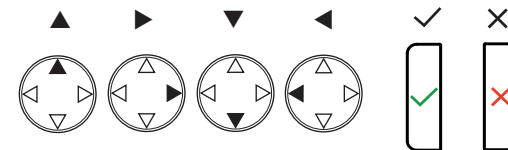

- > ▪ Proceeding to next step, next selection, etc. Example: Setting the phone language
- Nächster Schritt, nächste Auswahl etc. Beispiel: Ändern der Telefonsprache
- Passez à l'étape suivante, à la sélection suivante etc. Exemple: Modifier la langue du téléphone
- Avanzare allo prossimo passo, alla prossima selezione etc. Esempio: Cambiare la lingua del telefono
- Avanzar al siguiente paso, al siguiente selección. Ejemplo: Cambiar el idioma del teléfono

 > 1 Preferences > 4 Language > ▲ ▲ > Deutsch > ✓ > X

**This quick start guide describes the installation, setup, and operation of the snom 760. For further information please refer to the manual on our web page, <http://wiki.snom.com>.**

## **Copyright, Trademarks, GPL, Legal Disclaimers**

© 2012 snom technology Aktiengesellschaft  
All Rights Reserved.

snom, the names of snom products, and snom logos are trademarks owned by snom technology AG. All other product names and names of enterprises are the property of their respective owners.

snom technology AG reserves the right to revise and change this document at any time, without being obliged to announce such revisions or changes beforehand or after the fact.

Texts, images, and illustrations and their arrangement in this document are subject to the protection of copyrights and other legal rights worldwide. Their use, reproduction, and transmittal to third parties without express written permission may result in legal proceedings in the criminal courts as well as civil courts.

Although due care has been taken in the compilation and presentation of the information in this document, the data upon which it is based may have changed in the meantime. snom therefore disclaims all warranties and liability for the accurateness, completeness, and currentness of the information published, except in the case of intention or gross negligence on the part of snom or where liability arises due to binding legal provisions.

Our firmware includes some source code that may be used and modified by anyone and everyone under the GNU Public License (GPL) (see Appendix on page 59), provided they, in turn, make it available to everyone else with the same licensing agreement. Please go to <http://www.snom.com/en/support/download/gpl-quellcode/> for the original GPL license and the source code of components licensed under GPL and used in snom products.

## **Important Information**

Please read the instructions on safety and disposal and on how to set up and use the device before using it and also give them to other users to read or inform those users of their contents. Save this manual and do not give the device to third parties without it.

## **Safety Instructions**

Follow the instructions in this manual and other applicable documentation of the device.

- If the phone is not supplied with power via an Ethernet cable, use only a power adapter expressly recommended by snom technology. Other power supplies may damage or destroy the phone, affect its behavior, or induce noise.
- Avoid placing the cables where people may trip over them or where they may be exposed to mechanical pressure as this may damage them.

- This device is for indoor use only! NOT FOR OUTDOOR USE!
- Do not install the device in rooms with high humidity (for example, in bathrooms, laundry rooms, damp basements). Do not immerse the device in water and do not spill or pour liquids of any kind onto or into the device.
- Do not install the device in surroundings at risk for explosions (paint shops, for example). Do not use the device if you smell gas or other potentially explosive fumes.
- Do not use the device during thunderstorms. Lightning striking the power grid may cause electric shocks.
- **Warning:** The handset contains a magnet, and its earpiece may attract small dangerous objects such as needles or pins. Please ensure before each use that no such objects are present.

**SELV (Safety Extra Low Voltage) Compliance**

Safety status of Input/Output connections comply with SELV requirements.

**Warning:** To avoid electric shock, do not connect safety extra-low voltage (SELV) circuits to telephone-network voltage (TNV) circuits. LAN ports contain SELV circuits, and PSTN ports contain TNV circuits. Some LAN and PSTN ports both use RJ-45 (8P8C) connectors. Use caution when connecting cables.

**Standards conformance**



This device is CE and FCC-certified and meets European and US health, safety, and environmental standards. Unauthorized opening, changing, or modifying the device will cause the warranty to lapse and may also result in the lapse of the CE and FCC certifications. In case of malfunction contact authorized service personnel, your seller, or snom.

- **Safety:** IEC 60950-1:2007
- **Certifications:** FCC Class B, CE Mark
- **Power consumption:** 4 - 6 watts (without USB peripherals) ▪ **Power:** 5 V DC
- **1 x LAN, 1 x PC:** RJ45
- **Ethernet:** 2x IEEE 802.3/1 Gigabit switch
- **Power over Ethernet:** IEEE 802.3af, Class 2

**Disposal of the device**



This device is subject to European Directive 2002/96/EC and may not be disposed of with general household garbage.

If you do not know where you may dispose of the device at the end of its lifespan, contact your municipality, your local waste management provider, or your seller.

**Cleaning**

To clean the device, use an anti-static cloth. Please avoid cleaning liquids as they might damage the surface or internal electronics of the device.

**Setting up and connecting the phone**

See pages 2 - 3

**Initializing and registering the phone**

**Please note:** You will need the registration information received from your Internet service provider or your network administrator - normally the phone or extension number, the password, and the registrar.

After you have set up the phone and connected it to the network as shown on pages 2 - 3, the phone begins to initialize.

*Normally the initialization is completely automatic, using DHCP. If your network does not support DHCP, you must obtain the IP address, netmask, IP gateway, and DNS server from your Internet service provider or your network administrator and enter them manually when you are asked to do so on the display.*

Watch the display and, when asked to, make selections with ▼ / ▾ and save with ✓.

1. Language. The default is English.
2. Time zone
3. Dial tone
4. The display shows the "Welcome" screen. Press any key to log on.
5. Enter the account number. Save with ✓.
6. Enter the registrar. Press ✓.
7. Enter the password received from your Internet service provider or administrator. Press ✓. After successful registration you will see the green symbol with the handset:

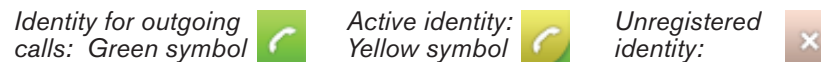

**Entering numerals, letters, and special characters**

Press any key or pick up handset.

**Input modes:**  
 123: Numerals  
 abc: Small letters  
 ABC: Capital letters

Current input mode: 123  
 Next input mode: abc C←

Changing input mode: [Navigation arrows]

Redial: [Redial button]

Directories, call lists, contact list, favorites: [Directories button]

◀: Move cursor to the left  
 ▶: Move cursor to the right  
 Delete character to the left of the cursor: [Delete button]

**Entering letters, special characters and symbols**

In input modes small and capital letters, press the alphanumeric key one or more times quickly, with a pause after each character.

**Special characters and symbols**

"0" key: 1x = space (" "), 2x = underscore ("\_"), 3x = 0

"1" key: . + @ 1 : , ? ! - \_ / \ ( ) ; & % \* # < = > \$ [ ] . Example: 3x = "@".

**Letters with accents and umlauts**

Keys "2" to "9": Available letters with accents and umlauts depend on the phone's language setting. Example: If the phone language is German, press key "2" four times to type "ä".

**AT A GLANCE**

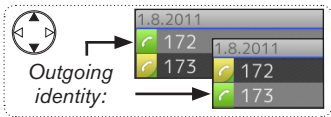

**CALL LED**

- BLINKING FAST: INCOMING CALL
- STEADY LIGHT: IN CALL OR
- MISSED CALL. PRESS X TO TURN OFF.

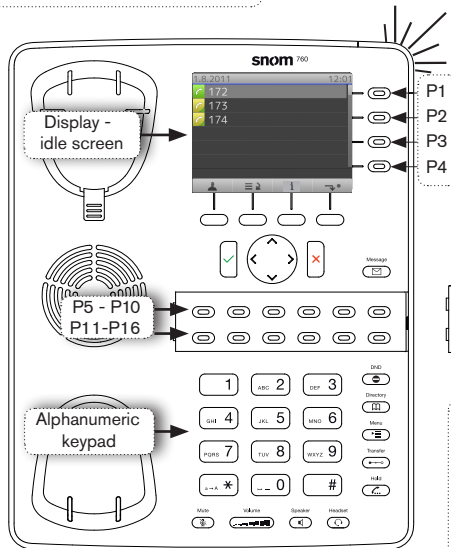

**FREELY PROGRAMMABLE LED KEYS P1 - P16**

- DEFAULT SETTING: LINE
- FAST-BLINKING LED: INCOMING CALL. PRESS KEY OR ✓ TO ACCEPT
  - STEADILY LIT LED: IN CALL
  - SLOW-BLINKING LED: CALL ON HOLD

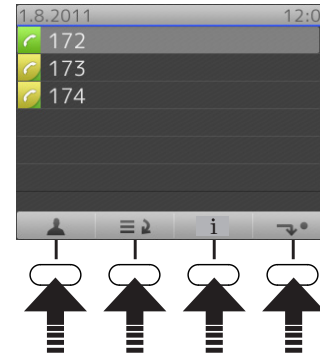

**Context-sensitive, programmable function symbols and function keys**

- Select outgoing identity, incl. inactive identities
- Call lists (missed, received, dialled calls)
- Forwarding all calls (on/off)
- Status information (call forwarding active, passwords not set, missed calls, etc.)

Press the function key to activate the function, open the list etc. depicted by the symbol above the key

- Confirming, saving actions & input
- From idle screen: **Redial**
- Canceling actions & input
- Turning off call LED after missed call

Selecting identity for outgoing calls

Missed calls

Received calls

**Dedicated, customizable function keys:**

- MWI (LED key) - if supported by PBX
  - Lit when message is waiting on mailbox
  - Press to listen to message(s)
- Turn DND (do not disturb) on/off
- Directory
- Settings menu
- Transfer call
- Hold/unhold call

**Audio control keys**

- Adjust volume
- Mute microphone
- Speakerphone on/off
- Headset on/off

**Star key**

- In editing mode:
  - Press for one second to change input mode (numerals > lower case > upper case)
  - Press briefly to type \*
- On idle screen: Press for 3 seconds to **lock/unlock the keypad**

**Pound (hash) key** #: Rescue mode for TFTP update

## Settings menu

- Press to open
- Press number key , , etc. to open submenus and settings
- Press , to select setting
- Press to save selected setting
- Settings with (On)/(Off) or (Yes)/(No): Press to change and save
- Press briefly to return to the previous screen
- Press for 2 seconds to return to idle screen

In administrator mode. Pressing key "2" will switch phone to user mode!

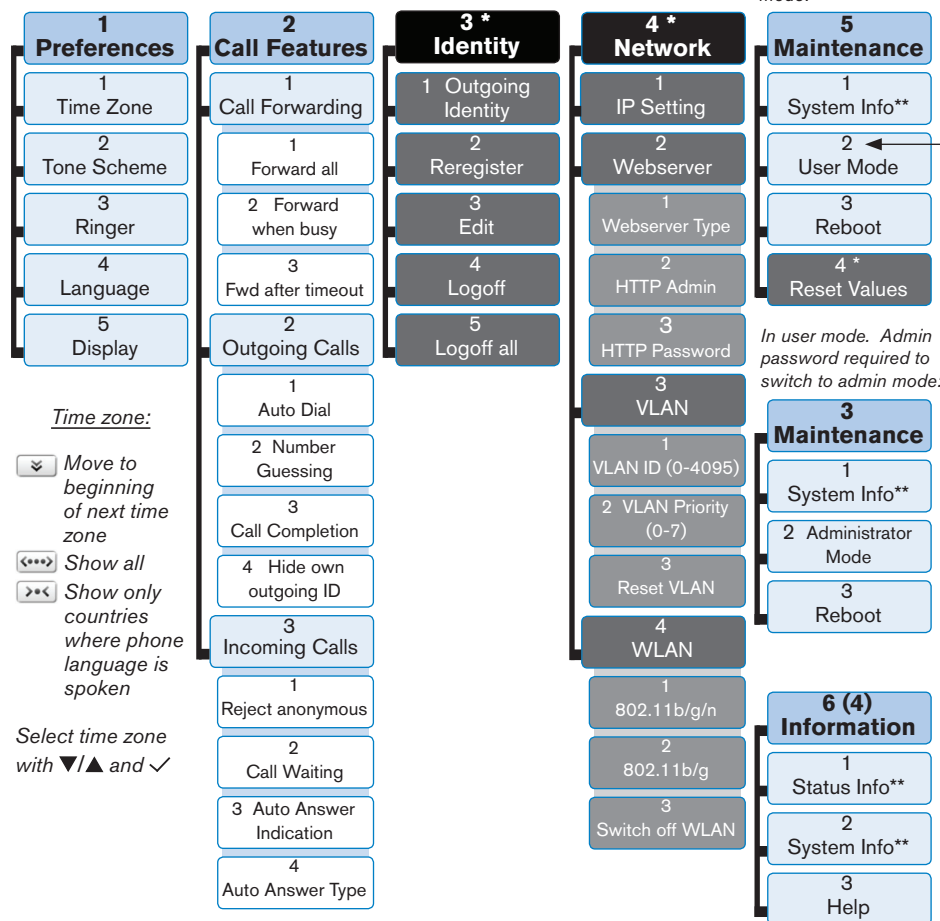

Time zone:  
 Move to beginning of next time zone  
 Show all  
 Show only countries where phone language is spoken  
 Select time zone with , and

\* The submenus and the settings shaded **black and gray** are not available when the phone is running in user mode. The factory setting is administrator mode. The default administrator password is 0000 (4 x zero).  
 \*\* System Info: Firmware version, **IP address**, MAC address, available + total memory

## The phone's web interface

- Look up the phone's IP address: > 6 Information > 2 System Info. Example: http://192.168.10.115.
- Open a web browser on your PC. Enter the IP address in the address bar and press ENTER. The "welcome" screen opens.
- Click on an item in the menu on the left side of the screen to open that window.

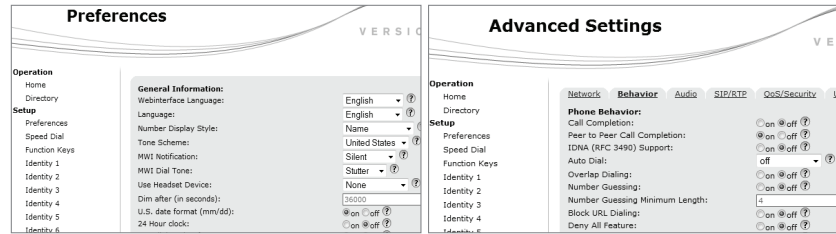

- If a window contains several pages, click on the tab at the top to open the page. The font weight of the characters on the tab of the visible page is **bold**.
- Any changes you make will not take effect until you click on "Apply". Changes will be lost if you open another page of the web interface or if you close the web interface without first clicking on "Apply".
- Whenever you click on "Apply", the "Save" button will appear at the top of the page. Click on "Save" to save the changes permanently. Changes that have not been saved will be lost if and when the phone loses power or is disconnected from its power source.

### Clock/time format

Web interface > Preferences > General Information > 24 Hour Clock:  
 On: 24-hour format, 00:00 to 23:59  
 Off: 12-hour AM/PM format, 0:00 AM to 11:59 PM

### Date format

Web interface > Preferences > General Information > US Date Format (mm/dd).  
 Example: March 8, 2010  
 On: 3/8/2010  
 Off: 8.3.2010

### Function keys

Function key mapping: Web interface of phone > Function Keys.  
 Change settings > Press "Save". Example: Mapping function keys P5 and P6 with the extension function for extensions 154 and 152, respectively

| Context | Type      | Number | Short Text |        |
|---------|-----------|--------|------------|--------|
| Active  | Extension | 154@   | admin      | P5 (5) |
| Active  | Extension | 152@   | Jane       | P6 (6) |

## Configuring & modifying identities

Web interface > Identity 1-12 > Login. See "Initializing and registering the phone" on page 9 for required and optional information.

## Using the phone

### Making calls

- Enter the number on the alphanumeric keypad and pick up the handset or
- pick up the handset, enter the number, ✓ or
- , enter the number, ✓

### Speed Dial

Type the speed dial number or character on the alphanumeric keypad and press ✓.

Setting the speed dial numbers: Web interface > Speed Dial. Type each phone number with any necessary area code and/or country code etc. without spaces, hyphens, etc. into one of the textboxes of the table. Do not add any names or other data. Example: To enter (911) 555-1234, type 9115551234.

### Emergency Numbers





These numbers can be called even when the keyboard is locked. The numbers "911", "112", "110", and "999" are preset.

Change/add numbers: Web interface > Preferences > Lock Keyboard > Emergency Numbers (space separated). Type each number without spaces, hyphens, etc. between the digits, separate the individual numbers with one empty space between them. Example: 911 112 110 999.

### Accepting calls

- With handset: Pick up the handset
- With a headset: Press ✓ or blinking line key
- With the speakerphone: Press 

### Putting calls on hold

Press . The LED starts to blink slowly. Press  again to resume the call. With more than one call on hold: Select a caller with  /  and resume the call by pressing ✓.

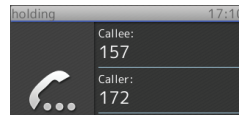



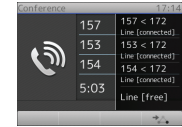

### Conference (up to 5 parties, including you)

1. Your phone number: 172. Put first party (157) on hold.

2. Call second party (153). Put on hold. Call third party (154). Press  to start conference.





3. Press  to stop conference and put parties on hold. Talking to one of the parties alone: Select with  / , press ✓.
4. Resume conference: Press .



## Call transfer

### Attended transfer



Put the call on hold  > Dial the number that you wish to transfer the call to > If the third party wishes to accept the call, press  and ✓.

### Blind transfer





With call ringing or on the line: Press  > dial the phone number the call is to be transferred to > press ✓.

## Call forwarding

1. All incoming calls.

- Turning on:  > Target when forwarding > enter number > ✓.
- Turning off: 

2. When busy.

- Turning on:  > 2 Call Features > 1 Call Forwarding > 2 Forward when busy > 2 Target when Forwarding: Enter number > ✓ > 1 Enable Forwarding: Press  => [Yes] > Press X for 2 seconds to return to idle screen
- Turning off:  > 2 Call Features > 1 Call Forwarding > 2 Forward when busy > 1 Enable Forwarding: Press  => [No] > Press X for 2 seconds to return to idle screen
- When call is not picked up.
- Turning on:  > 2 Call Features > 1 Call Forwarding > 3 Forward after Timeout > 2 Target when Forwarding > enter number > ✓ > 3 Call Forwarding time > enter number of seconds > ✓ > 1 Enable Forwarding: Press  => [Yes] > Press X for 2 seconds to return to idle screen
- Turning off:  > 2 Call Features > 1 Call Forwarding > 3 Forward after Timeout > 1 Enable Forwarding: Press  => [No] > Press X for 2 seconds to return to idle screen



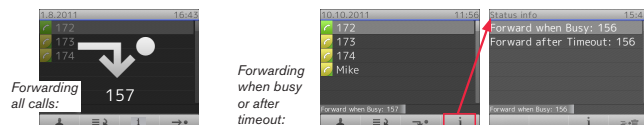

## Call lists

- Press .
- Select list of missed, received, dialed calls with > .
- Scroll through list with . Press to dial, press to show call details, press to delete entry. Press to delete entire list.

## Directory

- Opening list of names: Press .
- Shortcut to <New Item> at the end of the list: . Scroll with .
- Dial: . Details: . edit detail: . Delete entry: .

## Trouble shooting

### Reboot

> 5 Maintenance: > 3 Reboot: > "Reboot?" >

### Hard reboot

Disconnect power, wait for a few seconds, reconnect.

**Never disconnect the power during a firmware update!**

### Reset to factory values

> 5 Maintenance: > 4 Reset values: > enter administrator password >

**All customized settings will be lost!**

### TFTP Update

When there is no other way to get the phone to work (administrator password lost, etc.). How it is done: See [http://wiki.snom.com/Firmware/Update/TFTP\\_Update/en](http://wiki.snom.com/Firmware/Update/TFTP_Update/en).

**All customized settings will be lost!**

**Diese Kurzanleitung beschreibt die Installation, Einrichtung und den Betrieb des snom 760. Weitere Informationen finden Sie auf unserer Webseite, <http://wiki.snom.com>.**

## Copyright, Markenrechte, GNU Lizenz, Haftung

© 2012 snom technology Aktiengesellschaft  
Alle Rechte reserviert.

snom sowie die Namen der snom-Produkte und die snom logos sind gesetzlich geschützte Marken der snom technology AG. Alle anderen Produkt- und Firmennamen sind Marken der jeweiligen Inhaber.

snom technology AG behält sich jederzeit das Recht auf Überarbeitung und Änderung dieses Dokumentes vor, ohne verpflichtet zu sein, die vorgenommenen Änderungen anzukündigen oder mitzuteilen.

Texte, Bilder, Grafiken und deren Anordnung in diesem Dokument unterliegen weltweit dem Schutz des Urheberrechts und anderen Schutzgesetzen. Ihre Verwendung, Reproduktion oder Weitergabe ohne ausdrückliche schriftliche Zustimmung der snom technology AG können sowohl straf- als auch zivilrechtlich verfolgt werden.

Trotz der angewandten Sorgfalt bei der Zusammenstellung und Präsentation der Informationen in diesem Dokument können sich Daten zwischenzeitlich geändert haben. Daher übernimmt snom keine Gewähr für die Richtigkeit, Vollständigkeit oder Aktualität der zur Verfügung gestellten Informationen. Jegliche Haftung für Schäden ist ausgeschlossen, sofern diese nicht auf Vorsatz oder grober Fahrlässigkeit auf seiten von snom beruhen oder sofern keine Haftung aufgrund zwingender gesetzlicher Bestimmungen eintritt.

Unsere Firmware enthält teilweise Quellcodes, die unter der GNU Public License (GPL) (s. Seite 59) von jedermann genutzt und modifiziert werden dürfen, solange sie wiederum mit denselben Lizenzbedingungen zur allgemeinen Nutzung veröffentlicht werden. Die Quellcodes der von snom genutzten und der GPL unterliegenden Komponenten können Sie auf der Supportseite unserer Webseite auf [www.snom.com](http://www.snom.com), den Wortlaut der GPL auf <http://www.snom.com/de/support/download/gpl-quellcode/> herunterladen.

## Wichtige Hinweise

Lesen Sie bitte vor Inbetriebnahme die Sicherheitshinweise und die Bedienungsanleitung. Lassen Sie sie auch von den Mitbenutzern des Gerätes lesen oder informieren Sie sie über deren Inhalt. Bewahren Sie diese Bedienungsanleitung auf und geben Sie das Telefon nur mit der Bedienungsanleitung an Dritte weiter.

## Sicherheit

Befolgen Sie die Anweisungen in dieser Bedienungsanleitung und in der sonstigen Dokumentation des Geräts.

- Falls die Stromversorgung nicht über ein Ethernetkabel erfolgt, verwenden Sie nur

ein von snom ausdrücklich empfohlenes Netzteil. Die Verwendung anderer Netzteile könnte das Telefon beschädigen oder gar zerstören.

- Verlegen Sie die Netz- und Stromkabel so, dass sie durch mechanischen Druck nicht beschädigt werden und Personen nicht darüber stolpern könnten.
- Dieses Gerät ist nur für den Gebrauch in Innenräumen bestimmt - NICHT FÜR DEN AUSSENBEREICH!
- Stellen Sie das Telefon nicht in Räumen mit hoher Luftfeuchtigkeit wie z.B. Badezimmer, Waschküchen, feuchten Kellerräumen auf. Tauchen Sie das Telefon nicht in Wasser und gießen Sie keine Flüssigkeiten auf oder in das Gerät.
- Stellen Sie das Telefon nicht in explosionsgefährdeten Umgebungen (z.B. Lackierereien) auf. Benutzen Sie das Telefon nicht, wenn Sie Gas oder andere möglicherweise explosionsgefährliche Dämpfe riechen.
- Telefonieren Sie nicht während eines Gewitters (Stromschlaggefahr bei Blitzeinschlag ins Netz).
- **Warnung:** Der Hörer enthält einen Magneten und kann kleine gefährliche Objekte wie Nadeln anziehen. Bevor Sie ihn ans Ohr halten, vergewissern Sie sich, dass keine Objekte daran haften.

### SELV (Safety Extra Low Voltage) Einhaltung

Die Eingangs-/Ausgangsverbindungen halten die SELV-Richtlinien für Kleinspannungsgeräte ein.

**Warnung:** Um elektrische Schläge zu vermeiden, verbinden Sie keine SELV-Geräte mit Geräten, die Fernsprech-Netzspannung (TNV) führen. Nur an LAN-Ports anschließen! LAN-Ports enthalten SELV-Stromkreise, Festnetz-Anschlüsse dagegen TNV-Stromkreise. Vorsicht beim Anschließen, da beide Steckverbindungen RJ-45 (8P8C) verwenden könnten.

### Normkonformität

Dieses Gerät ist CE- und FCC-geprüft und entspricht den geltenden europäischen und US-amerikanischen Richtlinien.



Die eigenmächtige Öffnung des Geräts sowie Änderungen und Modifizierungen am Gerät führen zum Erlöschen der Gewährleistungspflicht und können darüberhinaus zum Erlöschen der Zulassungen führen. Wenden Sie sich bei Betriebsstörungen oder Defekten an autorisiertes Servicepersonal, an Ihren Verkäufer oder an snom.

- **Sicherheit:** IEC 60950-1:2007
- **Zertifikate:** FCC Class B, CE Mark
- **Stromspeisung:** Über Netzwerk (PoE, IEEE 802.3af, Klasse 2) oder Netzteil 5V DC
- **Leistungsaufnahme:** 4 - 6 Watt (ohne USB-Peripheriegeräte)
- **1 x LAN, 1 x PC:** RJ45
- **Ethernet:** 2x IEEE 802.3/1 Gigabit switch

### Reinigung

Benutzen Sie ein antistatisches Tuch. Benutzen Sie kein Wasser und keine Reinigungsflüssigkeiten, da sie die Oberfläche und die Elektronik des Gerätes beschädigen könnten.

### Entsorgung des Produkts



Dieses Gerät unterliegt der europäischen Richtlinie 2002/96/EG und darf nicht im Hausmüll entsorgt werden.

Wenn Sie nicht wissen, wo Sie Ihr Altgerät entsorgen können, wenden Sie sich bitte an Ihre Kommune, Ihren örtlichen Müllentsorger oder Ihren Fachhändler.

### Aufstellen und Anschließen des Telefons



Siehe S. 2 und 3

### Initialisierung und Registrierung des Telefons

**Beachten Sie bitte:** Sie benötigen die von Ihrem Netzwerkadministrator oder Ihrem VoIP-Provider erhaltenen Zugangsdaten für die Registrierung und Nutzung Ihres Accounts (Kontos), normalerweise Telefonnummer, Passwort und Registrar.



Sobald Sie das Telefon - wie auf den Seiten 2 - 3 gezeigt - an das Netzwerk angeschlossen haben, beginnt es mit der Initialisierung und Registrierung.

*Die Initialisierung erfolgt normalerweise automatisch über DHCP. Falls Ihr Netzwerk DHCP nicht unterstützt, benötigen Sie außerdem die IP-Adresse, den IP-Gateway und den DNS Server, die Sie ebenfalls von Ihrem Netzwerkadministrator oder VoIP-Provider erhalten, um sie manuell einzugeben, wenn Sie auf dem Display dazu aufgefordert werden.*

Treffen Sie bei Aufforderung auf dem Display Ihre Auswahl mit  und speichern Sie mit .

1. Sprache. Die Einstellung ab Werk ist Englisch.
2. Zeitzone
3. Rufton
4. Auf dem Bildschirm erscheint "Welcome". Drücken Sie eine beliebige Taste.
5. Geben Sie die Account/Telefon-Nummer ein > ✓. Eingabe von Zahlen, Buchstaben und Sonderzeichen: Siehe Seite 23.
6. Geben Sie den Registrar ein > ✓.
7. Geben Sie das Passwort ein, dass Sie von Ihrem VoIP-Provider oder Ihrem Netzwerkadministrator erhalten haben. Bei erfolgreicher Registrierung sehen Sie das grüne Symbol mit dem Hörer:

Infozeile mit Datum & Zeit → 1.8.2011 12:01  
 Konfigurierte Identität → 172

Identität für ausgehende Anrufe: Grünes Symbol     Aktive Identität: Gelbes Symbol     Nicht registrierte Identität: 

### Auf einen Blick

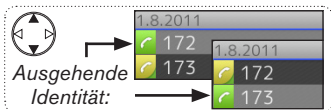



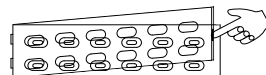
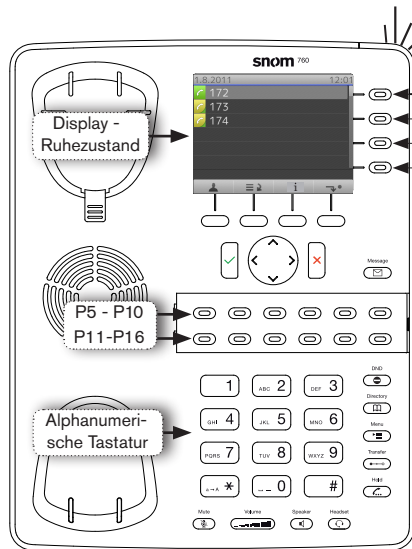

Ausgehende Identität: →

#### Anruf-LED

- Schnell blinkend: Eingehender Anruf
- Leuchtend: Im Gespräch ODER
- Verpasster Anruf. LED ausschalten: Drücken Sie auf X.



#### Audiotasten

-  Lautstärkeregelung
-  Mikrofon stummschalten
-  Freisprecheinrichtung ein/aus
-  Headset ein/aus



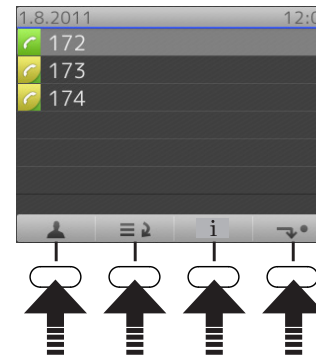

#### Frei programmierbare LED-Tasten

Standardeinstellung: Leitung

- Schnell blinkend: Eingehender Anruf
- Leuchtend: Im Gespräch
- Langsam blinkend: Gehaltener Anruf



#### Kontextsensitive, programmierbare Funktionssymbole und -tasten

-  Ausgehende Identität wählen, inkl. inaktiver Identitäten
-  Anruflisten (verpasste, erhaltene, gewählte Anrufe)
-   Alle Anrufe umleiten (an/aus)
-  Status-Informationen (bestehende Umleitungen, verpasste Anrufe, Passwörter nicht gesetzt, etc.)

Taste drücken, um im darüberliegenden Symbol angezeigte Funktion aufzurufen, Aktion durchzuführen etc.



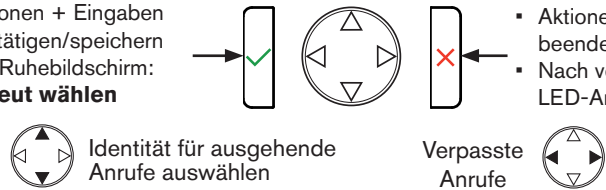



- Aktionen + Eingaben bestätigen/speichern
- Am Ruhebildschirm: **Erneut wählen**



- Aktionen + Eingaben beenden/abbrechen
- Nach verpasstem Anruf LED-Anzeige ausschalten

Identität für ausgehende Anrufe auswählen    Verpasste Anrufe    Empfangene Anrufe

#### Voreingestellte, programmierbare Funktionstasten:

-  LED-Taste "Neue Nachricht"
  - Leuchtet bei neuer Nachricht
  - Zum Abhören Taste drücken
-  "Bitte nicht stören" ein/aus
-  Telefonbuch
-  Menü Einstellungen
-  Anruf weiterleiten
-  Anruf auf Halten setzen/wieder aufnehmen

#### Sternchentaste

- Im Eingabemodus:
  - Drücken Sie  eine Sekunde lang, um zwischen Ziffern, Klein- und Großbuchstaben zu wechseln
  - Kurz drücken, um das Sternchen (\*) einzugeben
- Vom Ruhebildschirm aus: Taste drei Sekunden lang drücken, um die **Tastatur zu verriegeln/entriegeln**

#### Rautetaste #: Rescuemodus für TFTP-Update

## Menü Einstellungen

- drücken
- Zur Auswahl + Anzeige der Untermenüs und Einstellungen Nummerntasten 1, 2 usw. drücken
- Auswahl der Einstellung mit ▼/▲
- Ausgewählte Einstellung mit ✓ speichern
- Einstellungen mit (Ein)/(Aus) oder (Ja)/(Nein): Mit ✓ ändern und gleichzeitig speichern
- Mit x zum vorherigen Bildschirm zurück
- Mit zum Ruhebildschirm zurück

*Im Administratormodus. Durch Drücken der Taste 2 schalten Sie in den Benutzermodus um!*

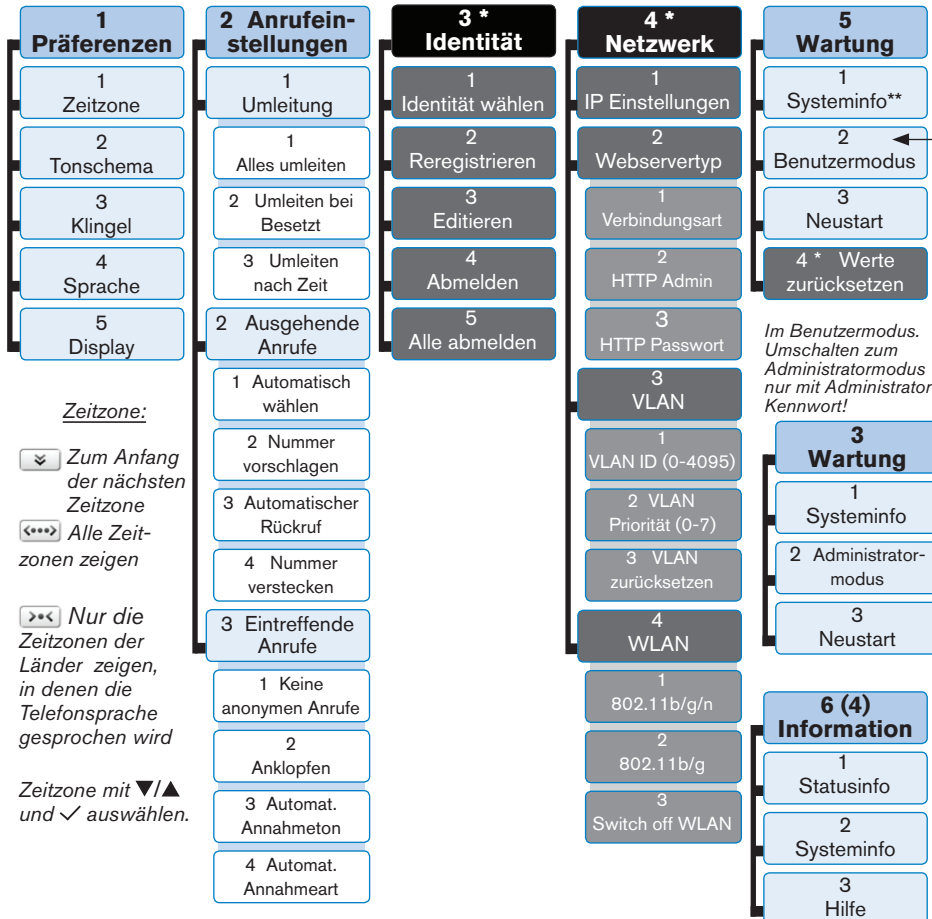

**Zeitzone:**

Zum Anfang der nächsten Zeitzone

Alle Zeit-zonen zeigen

Nur die Zeit-zonen der Länder zeigen, in denen die Telefonsprache gesprochen wird

Zeitzone mit ▼/▲ und ✓ auswählen.

## Der Webbrowser des Telefons

1. IP-Adresse anzeigen: Drücken Sie > 6 Information > Systeminfo. Beispiel: http://10.10.10.110.
2. Öffnen Sie den Webbrowser Ihres PCs, tippen Sie die IP-Adresse in die Adresszeile und drücken Sie auf die Bestätigen-Taste, um auf die Startseite des Telefon-Webrowsers zu gelangen.
3. Klicken Sie auf einen Menüpunkt auf der linken Seite, um das dazugehörige Fenster zu öffnen, z.B. Präferenzen.

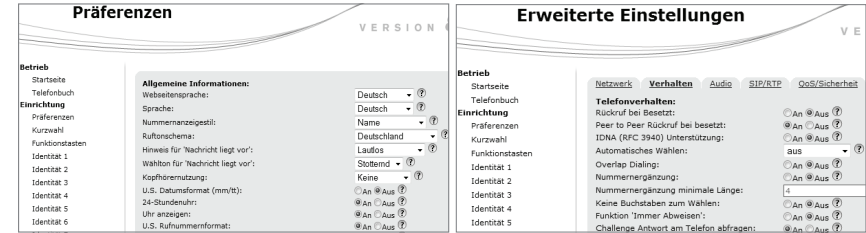

4. Enthält das Fenster mehrere Seiten, klicken Sie auf einen Tab ("Karteireiter") am oberen Rand, um die Seite sichtbar zu machen. Der Schriftschnitt der Textzeichen auf der sichtbaren Seite ist **fett**.
5. Klicken Sie vor dem Schließen des Telefonbrowsers oder dem Anklicken eines anderen Menüpunktes immer auf "Übernehmen", wenn die vorgenommenen Änderungen wirksam werden sollen.
6. Nachdem Sie auf "Übernehmen" geklickt haben, erscheint oben auf der Seite die Schaltfläche "Speichern". Klicken Sie darauf, um die Änderungen auf Dauer zu speichern. Nicht gespeicherte Änderungen gehen bei Stromausfall und bei Trennung des Telefons von der Stromversorgung verloren.

### Zeitformat

Webbrowser > Präferenzen > Allgemeine Informationen > 24-Stundenuhr:  
 An: 24-Stundenformat, 00:00 - 23:59  
 Aus: 12-Stundenformat AM/PM, 0:00 A to 11:59 P

### Datumsformat

Webbrowser > Präferenzen > Allgemeine Informationen > US Datumsformat (mm/tt).  
 Beispiel: 08.03.2010  
 An: 3/8/2010  
 Aus: 8.3.2010

\* Die **schwarz + grau unterlegten** Untermenüs und Einstellungen stehen im Benutzermodus nicht zur Verfügung. Die werkseitige Einstellung ist Administratormodus. Das werkseitig eingestellte **Administrator-Kennwort** lautet 0000 (4x Null).

\*\* Systeminfo: Firmware-Version, **IP-Adresse**, MAC-Adresse, freier + Gesamt-Speicher

## Funktionstasten

Funktionstasten einrichten: Webinterface des Telefons > Funktionstasten. Änderungen vornehmen > Speichern. Beispiel: Belegung der Funktionstasten P5 und P6 mit den Nebenstellen 154 und 152.

| Kontext | Typ         | Nummer        | Kurzform |        |
|---------|-------------|---------------|----------|--------|
| Aktive  | Nebenstelle | < sip:154@... | admin    | P5 (5) |
| Aktive  | Nebenstelle | < sip:152@... | Jane     | P6 (6) |

## Identitäts-/Kontoeinstellungen

Webbrowser > Identität 1-12 > Login. Erforderliche und optionale Eingaben: Siehe "Initialisierung und Registrierung des Telefons" auf Seite 19.

## Die Bedienung des Telefons

### Zahlen, Buchstaben und Sonderzeichen eingeben

Eine beliebige Taste drücken oder Hörer abheben.

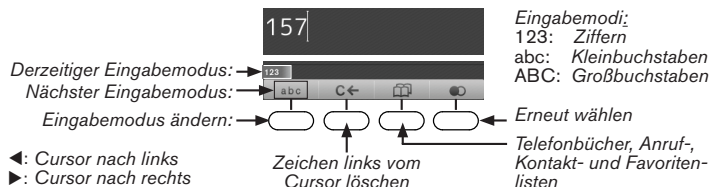

### Eingabe von Umlauten oder Buchstaben mit Akzenten

in den Eingabemodi Klein- u. Großbuchstaben.

Umlaute und Buchstaben mit Akzenten werden auf den Tasten "2" bis "9" eingegeben. Die verfügbaren Zeichen hängen von der eingestellten Telefonsprache ab. Drücken Sie die Taste, auf der jeweilige Buchstaben aufgedruckt ist, so oft, bis der gewünschte Umlaut oder der Buchstabe mit Akzent erscheint.

Beispiel: Bei Telefonsprache Deutsch drücken Sie viermal die Taste "2", um das "ä" einzugeben.

### Eingabe von Sonderzeichen

in den Eingabemodi Klein- u. Großbuchstaben: Taste schnell drücken, mit einer Pause nach jedem Zeichen.

Taste "0": 1 x = Leerzeichen (" "), 2x = Unterstrich ("\_")

Taste "1": . + @ 1 : , ? ! - \_ \ ( ) ; & % \* # < => \$ [ ]

Beispiele: 1x = "." ; 2x = "+", etc.

## Anrufen

- Nummer auf der alphanumerischen Tastatur eingeben und Hörer abheben oder
- Hörer abheben, Nummer eingeben, ✓ oder
- ☎, Nummer eingeben, ✓.

## Kurzwahl

Einstellung: Webbrowser > Kurzwahl. Geben Sie pro Textfeld eine Telefonnummer einschließlich der notwendigen Vorwahl/en ohne Leerstellen, Bindestriche usw. ein. Fügen Sie keine Namen oder sonstigen Angaben hinzu. Beispiel: Die Telefonnummer (030) 555-1234 geben Sie so ein: 0305551234.

Anwendung der Kurzwahl: Geben Sie die Kurzwahlnummer oder das Kurzwahlzeichen auf der alphanumerischen Tastatur ein und drücken Sie ✓.

## Notfallnummern

können auch dann angerufen werden, wenn die Tastatur verriegelt. Die Nummern "911", "112", "110" und "999" sind voreingestellt.

Änderung/Ergänzung: Webbrowser > Präferenzen > Tastatursperre > Notrufnummern (Leerzeichen-getrennt). Geben Sie jede Telefonnummer ohne Leerstellen, Bindestriche usw. innerhalb der Nummer ein, mit einer Leerstelle zwischen den einzelnen Telefonnummern. Eingabebeispiel: 911 112 110 999.

## Anrufe annehmen

- Mit dem Hörer: Hörer abheben
- Mit einem Headset: ✓ oder blinkende Leitungstaste drücken
- Mit dem Gehäuselautsprecher/-mikrofon: ☎ drücken.

## Anruf auf Halten setzen

☎ drücken. Die LED beginnt, langsam zu blinken. Anruf wieder aufnehmen: Erneut ☎ drücken. Wird mehr als ein Anruf gehalten: Mit ☎/☎ einen Anrufer auswählen und ✓ drücken, um mit ihm zu sprechen.

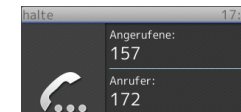

## Konferenz (bis zu 5 Teilnehmer, einschließlich Sie selbst)

1. Ihre Telefonnummer: 172. Ersten Anrufer (157) auf Halten setzen.
2. Zweiten Teilnehmer (153) anrufen. Auf Halten setzen. Dritten Teilnehmer (154) anrufen. Konferenz starten: ☎ drücken.

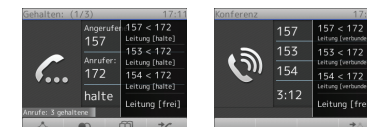

- Mit die Konferenz stoppen und alle Teilnehmer auf Halten setzen. Einzelgespräch mit einem der Teilnehmer: Wählen Sie mit / einen Teilnehmer aus und drücken Sie auf .

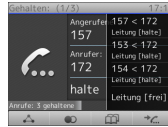

- Konferenz erneut starten: drücken.

## Anruf-Weiterleitung

### Mit Ankündigung

Anruf auf Halten setzen mit > Telefonnummer wählen, an die weitergeleitet werden soll. Will der Teilnehmer den Anruf entgegennehmen: und drücken.

### Ohne Ankündigung

Bei läutendem Anruf oder im Gespräch: > Telefonnummer wählen > .

## Rufumleitung

- Alle eingehenden Anrufe.
  - Einschalten: > Umleitungsziel: Telefonnummer eingeben >
  - Ausschalten:
- Bei Besetzt.
  - Einschalten: > 2 Anrufeinstellungen > 1 Umleitung > 2 Umleiten bei Besetzt > 2 Umleitungsziel: > Telefonnummer eingeben > > 1 Umleitung einschalten [Nein:  drücken ⇨ Ja] > 2 Sekunden lang drücken
  - Ausschalten: > 2 Anrufeinstellungen > 1 Umleitung > 2 Umleiten bei Besetzt: > 1 Umleitung einschalten [Ja ⇨ Nein] > 2 Sekunden lang drücken
- Wenn niemand abnimmt.
  - Einschalten: > 2 Anrufeinstellungen: > 1 Umleitung > 3 Umleiten nach Zeit > 2 Umleitungsziel > Telefonnummer eingeben > > 3 Zeit bis Umleitung > Anzahl der Wartezeit in Sekunden eingeben > 1 Umleitung einschalten [Nein:  drücken ⇨ Ja] > 2 Sekunden lang drücken
  - Ausschalten: > 2 Anrufeinstellungen > 1 Umleitung > 3 Umleiten nach Zeit > 1 Umleitung einschalten [Ja:  drücken ⇨ Nein] > 2 Sekunden lang drücken

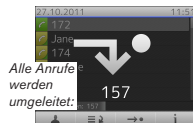

Umleiten bei Besetzt oder nach Zeitüberschreitung:

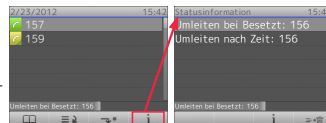

## Anruflisten

- Aufrufen vom Ruhebildschirm:
- Liste der verpassten, angenommenen oder gewählten Anrufe auswählen:
- Listeneintrag suchen: . Markierten Eintrag wählen: . Details (Nummer, Name, Zeit) anzeigen: . Eintrag löschen: .
- Liste löschen: .

## Telefonbuch

- Öffnen:
- Direkt zu <Neuer Eintrag> am Ende der Liste: . Eintrag suchen: .
- Markierten Eintrag wählen: . Details anzeigen: . Detail bearbeiten: . Eintrag löschen: .

## Fehlerbehebung

### Neustart (Reboot)

> 5 Wartung:  > 3 Neustart:  > "Neustart?" >

### Harter Neustart

Netzstecker ziehen. Telefon nach ein paar Sekunden wieder anschließen.

**Nie während eines Firmware-Updates die Stromzufuhr unterbrechen!**

### Werte zurücksetzen

> 5 Wartung:  > 4 Werte zurücksetzen:  > Admin. Modus  
Passwort: Administrator Kennwort eingeben >

**Alle persönlichen Einstellungen werden gelöscht!**

### TFTP-Update

Wenn es keine andere Möglichkeit mehr gibt, das Telefon zum Laufen zu bringen (Administratorpasswort verloren usw.). Wie es gemacht wird:  
[http://wiki.snom.com/Firmware/Update/TFTP\\_Update/de](http://wiki.snom.com/Firmware/Update/TFTP_Update/de).

**Alle persönlichen Einstellungen werden gelöscht!**

**Ce manuel abrégé décrit l'installation, l'initialisation et la mise en service du snom 760. Consultez notre site web pour des informations complémentaires:**

<http://wiki.snom.com>.

## Copyright, Marques Déposées, GPL, Non Responsabilité

© 2012 snom technology Aktiengesellschaft

Tous droits réservés.

snom, les noms des produits snom et les logos snom sont des marques déposées par snom technology AG. Tous les autres noms de produits et noms d'entreprises sont les propriétés de leurs détenteurs respectifs.

snom technology AG se réserve le droit de modifier et de changer ce document à n'importe quel moment, sans devoir annoncer de telles modifications ou changements avant ou après leur mise en place.

Les textes, images et illustrations ainsi que leur mise en page dans ce document sont protégés par les copyrights et autres dispositions légales internationales. Leur utilisation, leur reproduction et leur transmission à des parties tierces sans accord express écrit peut induire des poursuites devant les cours criminelles et civiles.

Bien que le plus grand soin ait été apporté à la compilation et à la présentation des informations contenues dans ce document, les données sur lesquelles elles sont basées peuvent entre-temps avoir été modifiées. snom doit donc décliner toute garantie et toute responsabilité quand à l'exactitude et à l'exhaustivité des informations publiées excepté en cas de négligence flagrante de la part de snom ainsi que des les cas où la responsabilité de snom est engagée de par la loi.

Notre firmware inclus des éléments de code source qui peuvent être utilisés et modifié par quiconque selon les termes des licences GPL (cf. page 59), à condition qu'à leurs tours ils les rendent disponibles selon les mêmes termes. Veuillez vous rendre sur <http://www.snom.com/de/support/download/gpl-quellcode/> pour consulter la licence GPL originelle et le code source des composants couverts par la licence GPL qui sont utilisé dans les produits snom.

## Informations importantes

Veuillez lire les informations concernant la sécurité et la mise au rebut de l'appareil ainsi que celles concernant son installation et son utilisation avant d'utiliser l'appareil. Communiquez également ces informations aux autres utilisateurs ou faites-les leur lire. Conservez ce manuel et ne cédez pas l'appareil à une tierce partie sans y joindre le manuel.

## Sécurité

Suivez les instructions présentes dans ce manuel et dans les autres documents concernant l'appareil.

- Évitez de placer les câbles de l'appareil dans un endroit où il est possible de trébucher dessus. Évitez également de les placer là où ils pourraient être exposé à un écrasement car ils pourraient en être endommagé. Si les câbles ou la fiche sont endommagés, débranchez l'appareil et contactez du personnel d'entretien qualifié.
- Cet appareil est destiné à une utilisation en intérieur uniquement! **Ne l'installez pas au dehors!**

- N'installez pas l'appareil dans des pièces très humides (par exemple, dans une salle de bain, une buanderie ou un sous-sol humide). N'immergez pas l'appareil dans l'eau et ne versez pas de liquides d'aucune sorte sur ou dans l'appareil.
- N'installez pas l'appareil dans un lieu présentant un risque d'explosion (un magasin de peinture par exemple). N'utilisez pas l'appareil si vous sentez une odeur de gaz ou d'autres émanations potentiellement explosives.
- N'utilisez pas l'appareil durant les orages, le choc d'un éclair sur les circuits électriques peut provoquer une électrocution.
- **Avertissement:** Le combiné contient un aimant, et son écouteur pourrait attirer de petits objets dangereux tels que des aiguilles ou des épingles. Assurez-vous avant chaque utilisation que de tels objets ne sont présents.

### Conforme à SELV (Safety Extra Low Voltage) - TBTS (Très Basse Tension de Sécurité)

Le niveau de sécurité des connexions d'entrée/sortie est conforme aux recommandations SELV /TBTS.

**Avertissement:** Pour éviter des électrocutions, ne connectez pas les circuits de SELV / TBTS à des circuits de tension de réseau téléphonique (Telephone Network Voltage ou TNV). Ne connectez le câble NET/Ethernet qu'à des ports du réseau local (LAN) qui contiennent des circuits SELV. Les ports du Réseau Téléphonique Commuté Public (RTCP ou PSTN) sont munis de circuits TNV.

### Conformité au standards



Cet appareil est certifié CE et FCC et répond aux standards environnementaux, de sécurité et de santé européens et américains.

L'ouverture, la modification ou le remplacement sans autorisation de l'appareil annule la garantie et peut également annuler les certifications CE et FCC. En cas de mauvais fonctionnement, veuillez contacter le personnel d'entretien agréé, votre revendeur ou bien snom.

- **Sécurité:** IEC 60950-1:2007
- **Certificats:** FCC Class B, CE Mark
- **1 x LAN, 1 x PC:** RJ45
- **Ethernet:** 2x IEEE 802.3/1 Gigabit switch
- **Alimentation:** Par PoE (Power over Ethernet) IEEE 802.3af, Classe 2 ou transformation 5 V DC (pas inclus dans la boîte)
- **Consommation d'énergie:** 4 - 6 Watts (without USB peripherals)

### Mise au Rebut du Produit



Cet appareil est soumis à la Directive 2002/96/CE et ne peut être mis au rebut avec les déchets ménagers normaux.

Si vous ne savez pas où mettre au rebut ou faire recycler l'appareil lorsqu'il arrive au terme de son existence, contactez votre municipalité, la société locale en charge de la gestion des déchets ou votre vendeur.

### Nettoyage

Utilisez un tissu antistatique. N'utilisez pas de l'eau ou un produit de nettoyage liquide ou solide. Ils peuvent endommager l'électronique ou les surfaces de l'appareil.

**Installer et connecter le telephone:** Voir pages 2 - 3.

### Initialisation et enrégistration

**Renseignement:** Vous devez également disposer des données pour la registration et l'utilisation de votre compte que vous avez reçu de votre administrateur réseau ou de votre fournisseur de VoIP, normalement la numéro de téléphone, le mot de passe et le registraire.

Une fois que l'appareil est connecté avec le réseau comme indiqué sur les pages 2 - 3, il commence à s'initialiser et se registrar.

*L'initialisation est normalement fait automatiquement via DHCP. Si votre réseau ne supporte pas le protocole DHCP, vous devez également saisir l'adresse IP, la passerelle IP et le serveur DNS manuellement. Demandez-les de votre administrateur réseau ou de votre fournisseur de VoIP et suivez les instruction qui s'affichent à l'ecran.*

Après l'initialisation, le téléphone va vous conduire à travers les paramètres de base.

Sélectionnez une option avec ▼/☑ et sauvegardez chaque sélection avec ✓.

1. Langue. Le paramètre par défaut est Anglais.
2. Fuseau horaire
3. Tonalité
4. Ecran de bienvenue: "Welcome". Appuyez sur une touche alphanumérique quelconque pour vous loguer.
5. Saisissez votre numéro de téléphone/compte + appuyez sur ✓
6. Saisissez votre registraire et appuyez sur ✓.
7. Saisissez le mot de passe que vous avez recu de votre fournisseur de VoIP, ou votre administrateur et appuyez su ✓. Si l'enregistrement a réussi l'écran d'attente avec le symbole vert s'affiche:

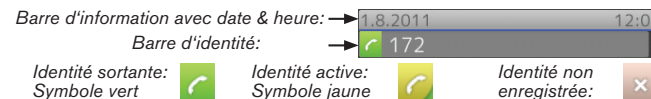

### Saisie de lettres, chiffres et caractères spéciaux

Appuyez sur une touche alphanumérique quelconque ou décrochez le combiné.

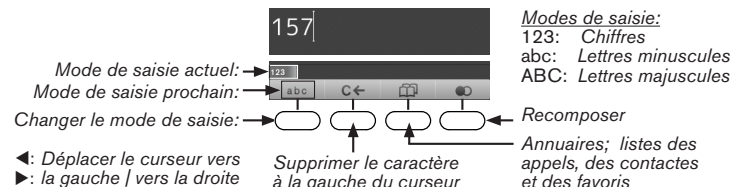



### Saisie de lettres, caractères spéciaux et symboles

En modes de saisie lettres minuscules et majuscules: Appuyez rapidement plusieurs fois sur la touche respective, avec une petite pause après chaque caractère.

### Caractères spéciaux et symboles

La touche "0": 1x = espace (" "); 2x = tiret inférieur ("\_"); 3x = 0

La touche "1": . + @ 1 : , ? ! - \_ / \ ( ) ; & % \* # < = > \$ [ ]

Exemples: 1x = ".", 2x = "+" etc.

### Saisie de voyelles infléchies et caractères accentués

Touches "2"- "9". Les caractères disponibles dépendent de la langue sélectionnée. Par exemple: Si la langue sélectionnée est le français, appuyez sur la touche quatre fois pour saisir le "à", sept fois pour saisir le "ç".

### D'un seul coup d'oeil

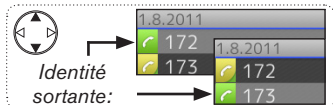

### Diode d'indication d'appel

- Clignotement rapide: Appel entrant
- Allumé: Appel en cours OU
- Appel manqué. L'éteindre: Appuyez sur X.

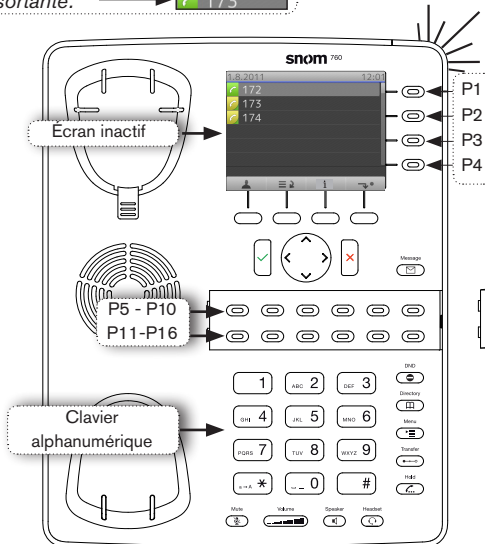

### Touches audio

- Réglage du volume
- Microphone (arrêt/marche)
- Haut-parleur (marche/arrêt)
- Casque (marche/arrêt)

**Touche dièse** #: Mode "Re-scue" (réinitial. avec TFTP)

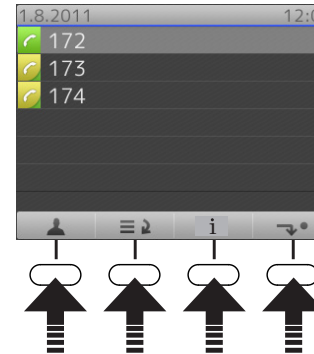

### Symboles contextuelles des fonctions personnalisables

- Sélectionner l'identité sortante (identités inactives inclus)
- Listes des appels (manqués, recus, composés)
- Renvoyer tous les appels (marche/arrêt)
- Informations d'état (renvois d'appels actifs, appels manqués, mots de passe pas définis, etc.)

Appuyer sur la touche de fonction au-dessous du symbole contextuel pour activer la fonction indiquée là, initier une action etc.

- Confirmer/sauvegarder des actions/entrées
- De l'écran inactif: **Re-composer**

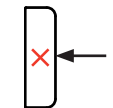
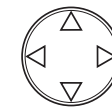
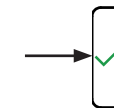

- Annuler des actions/saisies
- Éteindre la diode après un appel manqué



Sélectionner l'identité pour des appels sortants



Appels manqués



Appels reçus

### Touches de fonction programmables avec diodes

Défaut: Ligne

- Clignotement rapide: Appel entrant
- Allumé: Appel en cours
- Clignotement lent: Appel en attente

### Touches de fonction programmés:

- Touche "Nouvel message" avec diode
  - Allumé: Nouvel message
  - Appuyez sur la touche pour écouter le nouvel message
- Mode "Ne pas déranger" en marche/arrêt
- Annuaire
- Menu Paramètres
- Transférer un appel
- Mettre un appel en attente

### Touche astérisque

- En mode de saisie:
  - Appuyé pour 3 secondes: Passer entre modes chiffres, lettres minuscules et lettres majuscules.
  - Appuyé brièvement: Saisir l'asterisque (\*)
- En mode inactif: Appuyé pour 3 secondes: **Verrouiller/déverrouiller le clavier**

## Menu Paramètres

- Appuyez sur
- Sélectionner un sous-menu ou un paramètre: Appuyez sur la touche numérique correspondante , etc.
- Sélectionner un paramètre: ▼/▲
- Sauvegarder votre modification: ✓

- Paramètres avec (Marche)/(Arrêt) ou (Oui)/(Non): Modifier et sauvegarder simultanément avec ✓
- Retourner à l'écran précédent: X
- Retourner à l'écran inactif:

En mode administrateur. Appuyez sur la touche 2 pour passez le téléphone en mode utilisateur!

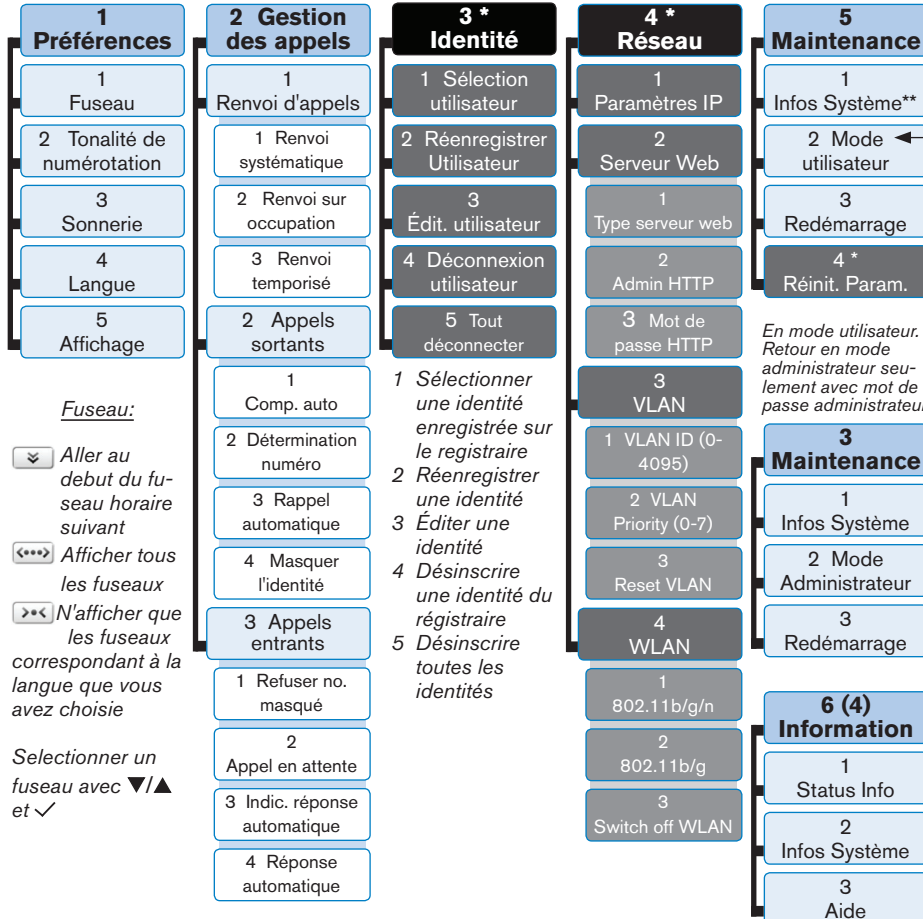

\* Les sous-menus et paramètres en **panneaux gris et noir** ne sont pas disponibles en mode utilisateur. La réglage par défaut est le mode administrateur. Le **mot de passe administrateur** par défaut est 0000 (4 x zéro).

\*\* Infos Système: Version de logiciel, **adresse IP**, adresse MAC, mémoire totale + libre

## L'interface Web du téléphone

- Obtenir l'adresse IP: > 6 Information > 2 Infos Système, p.ex. 192.168.10.115.
- Ouvrez le navigateur web de votre PC et saisissez l'adresse IP dans la barre d'adresse, p.ex. http://192.168.10.115. Appuyez sur la touche d'entrée pour ouvrir la page d'accueil de l'interface Web du téléphone.
- Cliquez sur un élément au menu à gauche pour ouvrir la page correspondante.

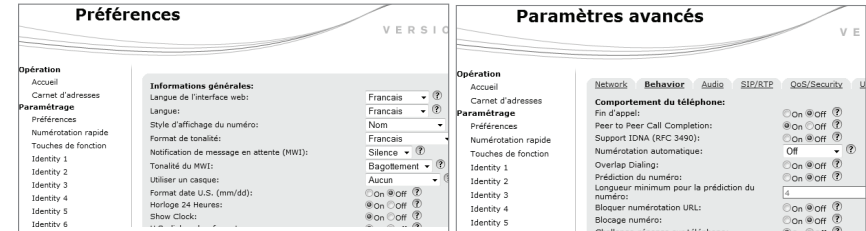

- Certaines pages contiennent plusieurs documents. Pour rendre visible un document, cliquez sur l'onglet correspondant. Les lettres de l'onglet actif sont affichées en caractères **gras**.
- Appuyez toujours sur la touche "Apply" avant de cliquer sur un menu différent ou de refermer l'interface web si vous désirez appliquer les modifications que vous avez effectuées.
- Chaque fois que vous cliquez sur "Appliquer", le "sauvegarder" bouton apparaîtra en haut de la page. Cliquez sur "Sauvegarder" pour enregistrer les modifications de façon permanente. Les modifications qui n'ont pas été enregistrées seront perdues si et lorsque le téléphone n'est plus alimenté ou est déconnecté de sa source d'alimentation.

### Format de l'heure

Interface Web > Préférences > Informations généraux > Horloge 24 Heures

- On: Format 24 heures, 00:00 - 23:59
- Off: Format 12 heures AM/PM, 0:00 AM - 11:59 PM

### Format de la date

Interface Web > Préférences > Informations généraux > Format date U.S. (mm/dd).

Exemple: Le 8 mars 2010.

- On: 3/8/2010
- Off: 8.3.2010

### Touches de fonction

Configurer les touches de fonction: Interface web du téléphone > Touches de fonction. Modifier les paramètres > Sauvegarder. P. ex.: Dédié les touches de fonction P5 et P6 à la fonction "extension" pour les postes intérieurs 154 et 4403.

| Contexte | Type      | Numéro      | Short Text |        |
|----------|-----------|-------------|------------|--------|
| Active   | Extension | < sip:154@  | admin      | P5 (5) |
| 4400@    | Extension | < sip:4403@ | Jane       | P6 (6) |

## Paramètres d'identité/compte

Interface Web > Identité 1-12 > > Login. Voir "Initialisation et enrégistration" à la page 31 pour les données requises et optionnelles.

## Utiliser le téléphone

### Passer des appels

- Saisissez le numéro sur le clavier alphanumérique et décrochez le combiné ou
- Saisissez le combiné, saisissez le numéro et appuyez sur ✓ ou
- , saisissez le numéro, ✓.

### Composition Rapide

Configuration: Interface Web > Numérotation Rapide. Saisissez un seul numéro avec tous les préfixes requis dans chaque zone de texte, sans espaces libres, sans traits d'union ou d'autres signes de ponctuation. N'ajoutez pas de nom avant ou après le numéro ! P. ex: Saisissez le "(01) 23.45.67.89" comme "0123456789".

Utilisation: Saisissez un numéro (0 - 30) ou les caractères spéciaux # ou \* et appuyez sur ✓.

### Numéros d'urgence





Ils peuvent être composés même lorsque le clavier est verrouillé. Paramètres par défaut: "911", "112", "110", "999".

Configuration sur l'interface web du téléphone: Interface Web > Préférences > Verrouillage clavier > Emergency Numbers (space separated). Saisissez chaque numéro sans espace entre les chiffres, séparez les numéros par un espace vide. P. ex: 911 112 110 999.

### Accepter des appels

- Avec le combiné: Décrochez le combiné
- Avec un casque: Appuyez sur ✓ ou la touche clignotante de la ligne
- Avec le haut-parleur/microphone du boîtier: Appuyez sur 

### Placer un appel en attente

Appuyez sur . La diode commence à clignoter lentement. Reprendre l'appel: Appuyez sur . S'il y a plus qu'un seul appel en attente: Sélectionnez un d'eux avec  /  et appuyez sur ✓.

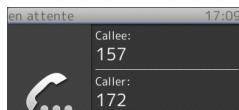



### Conférence (5 participants en tout, vous y compris)

1. Votre numéro de téléphone: 172. Mettez le premier appel (157) en attente.

2. Appelez la deuxième partie (153). Mettez-la en attente. Appelez la troisième partie (154). Appuyez sur  pour démarrer la conférence.





3. Appuyez sur  pour arrêter la conférence et mettre les participants en attente. Parler à un seul participant: Sélectionnez un d'eux avec  /  et appuyez sur ✓.



4. Recommencer la conférence: Appuyez sur .

## Transfert d'un appel











### Attendu

Mettre l'appel en attente  > Composez le numéro du nouveau poste destinataire. Annoncez l'appel > Si la tierce partie veut l'accepter: Appuyez sur  et ✓.

### Sans l'annoncer au poste destinataire

Quand un appel sonne ou avec un appel en ligne: Appuyez sur  > composez le numéro du nouveau poste destinataire > appuyez sur ✓.

## Renvoi d'appel

1. Tous les appels entrants.
  - Activer:  > Numéro où renvoyer > composez le numéro du poste destinataire > ✓
  - Désactiver: 
2. Sur occupation.
  - Activer:  > 2 Gestions des appels > 1 Renvoi d'appels > 2 Renvoi sur occupation > 2 Numéro où renvoyer > composez le numéro du poste destinataire > ✓ > 1 Activation du renvoi [Non: Appuyez sur  ⇒ OUI] > X pour 2 secondes
  - Désactiver:  > 2 Gestions des appels > 1 Renvoi d'appels > 2 Renvoi sur occupation > 1 Activation du renvoi [Oui: Appuyez sur  ⇒ Non] > X pour 2 secondes
3. Après un délai de réponse.
  - Activer:  > 2 Gestions des appels > 1 Renvoi d'appels > 3 Renvoi temporisé > 2 Numéro où renvoyer > composez le numéro du poste destinataire > ✓ > 3 Attente en secondes > saisissez le numero de secondes > ✓ > 1 Activation du renvoi [Non: Appuyez sur  ⇒ OUI] > X pour 2 secondes.
  - Désactiver:  > 2 Gestions des appels > 1 Renvoi d'appels > 3 Renvoi temporisé > 1 Activation du renvoi [Oui: Appuyez sur  ⇒ Non] > X pour 2 secondes.







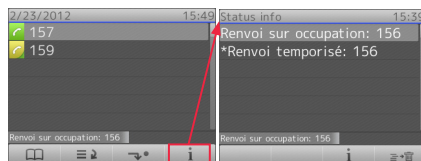

Renvoi de tous les appels entrants sur un autre poste:









Renvoi si votre poste est occupé et renvoi temporisé:



## Listes des appels manqués, recus et appelés

- Appuyez sur .
- Sélectionner la liste des appels manqués (perdu), recus, appelés:   > .
- Chercher un appel dans la liste:  . Composer le numéro: . Afficher les détails de l'appel à l'écran: . Supprimer l'entrée: . Supprimer la liste: .

## Annuaire du telephone

- Ouvrir l'annuaire: Appuyez sur .
- Faire défiler les entrées:  . Aller directement à <Nouvelle Entrée>: .
- Composer le numéro: ; Détails: ; Éditer un détail: ; Supprimer l'entrée: .

## Dépannage

### Redémarrage (Reboot)





 > 5 Maintenance:  > 3 Redémarrage  > "Redémarrer?" > 

### Redémarrage à froid

Retirez la prise de courant. Rebranchez l'alimentation après quelques secondes.

**Ne coupez pas l'alimentation pendant une mise à jour du firmware !**

### Réinitialiser aux valeurs d'usine (remettre à zero)

 > 5 Maintenance:  > 4 Réinit. Para.:  > saisissez le mot de passe administrateur > 

**Tous les paramètres personnalisés seront écrasés !**

### TFTP Update (réinitialisation aux valeurs d'usine avec TFTP)

Quand il n'y a pas d'autre moyen pour faire fonctionner le téléphone ou d'accéder à l'interface web (mot de passe administrateur perdu ou oublié, etc.). Comment le faire: Voir [http://wiki.snom.com/Firmware/Update/TFTP\\_Update/en](http://wiki.snom.com/Firmware/Update/TFTP_Update/en).

**Tous les paramètres personnalisés seront écrasés !**

**Questa è la guida rapida per l'installazione, l'impostazione e il funzionamento dello snom 760. Per ulteriori informazioni consultare la nostra pagina web: <http://wiki.snom.com>.**

## Copyright, Marchi registrati, GPL, Declinazione di responsabilità

© 2012 snom technology Aktiengesellschaft  
Tutti i diritti riservati.

snom, i nomi dei prodotti snom, ed i loghi snom sono marchi registrati di proprietà di snom technology AG. Tutti gli altri nomi di prodotti e di imprese sono proprietà dei rispettivi proprietari.

snom technology AG si riserva il diritto di rivedere e modificare il presente documento in qualsiasi momento senza alcun obbligo di notifica precedente o posteriore a tali cambiamenti.

Testi, immagini ed illustrazioni ed il loro ordine in questo documento sono soggetti a protezione del diritto d'autore ed altri diritti legali a livello mondiale. Il loro utilizzo, riproduzione e trasmissione a terzi senza il permesso scritto di snom potrebbe dar luogo ad azioni legali, in sede penale e civile.

Sebbene sia stata prestata la massima attenzione nella stesura e presentazione delle informazioni in questo documento, i dati su cui si basa potrebbero già aver subito variazioni. snom pertanto declina ogni responsabilità riguardo a tutte le garanzie di affidabilità, accuratezza, completezza ed attualità delle informazioni pubblicate, tranne nel caso di grossolana negligenza da parte di snom o laddove per legge possa essere ritenuta responsabile.

Il nostro firmware include codice sorgente utilizzabile e modificabile da chiunque. La licenza pubblica GNU (GPL) (cfr. pag. 59), consente di rendere disponibile il software con lo stesso accordo di licenza. Visitate <http://www.snom.com/de/support/download/gpl-quellcode/> per la licenza GPL originale e per i codici di sorgente di componenti sotto licenza GPL ed utilizzati in prodotti snom.

## Informazioni importanti

Pregasi leggere con attenzione le istruzioni inerenti la sicurezza, lo smaltimento e l'installazione del dispositivo prima del suo impiego. Tali informazioni vanno condivise con gli altri utenti. È altresì necessario conservare questo manuale, consegnandolo insieme al dispositivo qualora esso venga dato a terzi.

## Sicurezza

Seguite le istruzioni in questo manuale e tutta la documentazione relativa al dispositivo.

- Non posizionare i cavi del telefono dove può essere calpestato. Non posizionare i cavi del telefono dove può essere soggetto a pressione meccanica perché potrebbe danneggiare i cavi. Se i cavi o la spina si danneggiano, scollegare il telefono e contattare il personale di assistenza qualificato.

- Questo apparecchio si può impiegare solo al chiuso! **Non installare all'aperto!**
- Non installare il dispositivo in ambienti con alta umidità (ad es., in bagno, lavanderia, seminterrati umidi). Non immergere il dispositivo in acqua e non versarvi liquidi sopra
- Non installare il dispositivo nei pressi di locali a rischio esplosione (colorifici, ad es.). Non utilizzare il dispositivo se sentite odore di gas o di altra esalazione potenzialmente esplosiva.
- Non utilizzare il dispositivo durante i temporali. Qualora un fulmine colpisca la rete elettrica, è passibile di scossa.
- **Attenzione:** La cornetta contiene un magnete che potrebbe attirare oggetti pericolosi tra cui eventualmente chiodi. Prima di portarla all'orecchio assicuratevi che nessun oggetto vi sia attaccato.

### Conforme al circuito SELV (bassissima tensione di sicurezza)

Il livello di sicurezza dei circuiti in ingresso / uscita è conforme alle raccomandazioni SELV.

**Attenzione:** Per evitare scosse elettriche non collegare i circuiti SELV a quelli della rete telefonica (TNV). Le porte LAN hanno circuiti SELV, le porte PSTN hanno circuiti TNV.

### Conformità



Il dispositivo è certificato CE e FCC e risponde agli standard europei e statunitensi di salute, sicurezza ed ambientali.

Eventuali modifiche, cambiamenti e l'apertura non autorizzata del dispositivo invalidano la garanzia e potrebbero eventualmente annullare le certificazioni CE e FC. In caso di malfunzionamento contattare il personale di assistenza autorizzato, il rivenditore, o snom.

- **Sicurezza:** IEC 60950-1:2007
- **Certificazioni:** FCC Class B, Marchio CE
- **Consumo di potenza:** 4 - 6 Watt (senza periferie USB)
- **Potenza:** PoE (Power over Ethernet) IEEE 802.3af, Class 2 o 5 V DC
- **1 x LAN, 1 x PC:** RJ45
- **Ethernet:** 2 interruttori IEEE 802.3 da 1 Gigabit switch

### Smaltimento del dispositivo



Questo dispositivo è soggetto alla Direttiva Europea 2002/96/EC e non può essere smaltito con i rifiuti domestici.

Se non sapete come smaltire l'apparecchio una volta inutilizzabile, contattate il comune, la nettezza urbana locale, o il vostro rivenditore.

### Pulizia

Utilizzare un panno antistatico. Evitare acqua e altri liquidi o detergenti solidi che potrebbero danneggiare la superficie o l'elettronica interna.

### Installare e collegare il telefono: Vedi pag. 2-3

### Inizializzazione e registrazione

**Nota:** Sono necessarie le informazioni di registrazione ricevute dal provider o amministratore del sistema – generalmente il numero di telefono o numero interno, la password e il Registrar.

Una volta impostato il telefono e averlo collegato alla rete come indicato alle pagine 2 - 3, il telefono avvia la procedura di inizializzazione.

*Di norma la procedura di inizializzazione si svolge in maniera completamente automatica, mediante protocollo DHCP. Se la rete non supporta il protocollo DHCP, è necessario ottenere indirizzo IP, maschera di rete, gateway IP e server DNS dal fornitore di servizi internet o amministratore di rete, quindi inserirli manualmente quando viene richiesto sullo schermo.*

Selezionare un'opzione con ▼/☑ e salvare ogni selezione con ✓.

1. Lingua. La lingua standard è l'inglese.
2. Fuso orario
3. Segnale di linea libera
4. Schermo benvenuto: "Welcome". Premere un tasto qualsiasi.
5. Digitare il tuo numero di conto/telefono + premere ✓
6. Inserire i dati del Registrar + ✓.
7. Digitare la password. Se la registrazione è riuscita, il display visualizza la schermata inattivo con il simbolo verde:

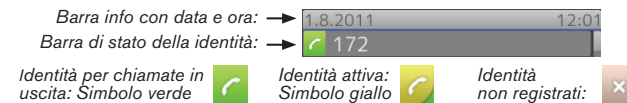

### Inserire lettere, numeri e caratteri speciali

Premere un qualsiasi tasto alfanumerico.

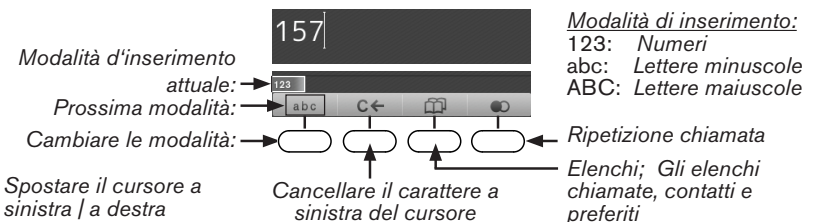

### Digitare lettere e caratteri speciali

In le modalità lettere minuscole o maiuscole: Premere rapidamente il tasto più volte, con una piccola pausa dopo ogni lettera.

### Caratteri speciali

Il tasto "0": 1 x = spazio (" "), 2x = trattino basso ("\_"), 3 x = 0

Il tasto "1": . + @ 1 ; ? ! - \_ / \ ( ) ; & % \* # <=> \$ [ ]. Es: 1x = ".", 2x = "+" etc.

### Digitare metafonesi e caratteri accentati

Premere il tasto col carattere desiderato più volte. I caratteri disponibili dipendono dalla lingua impostata. Esempio: In Italiano, premere il tasto "3" cinque volte per digitare la lettera è.

### In sintesi

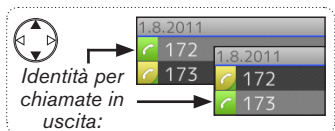

#### LED di chiamate

- Lampeggia rapidamente: Chiamata in arrivo
- Luce costante: Chiamata in corso O
- Chiamata perse. Spegnerlo: Premere X.

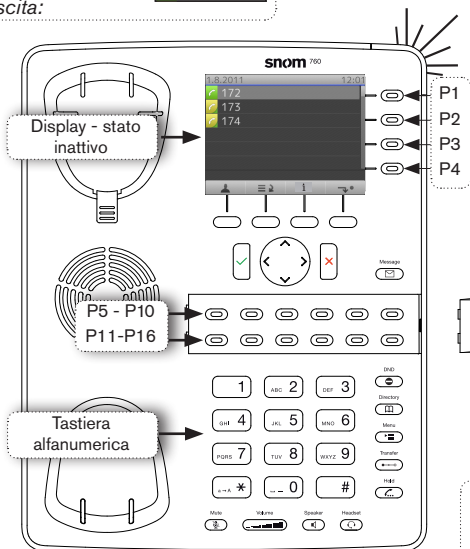

#### Tasti audio

- Modificare il volume
- Microfono (on/off)
- Vivavoce (on/off)
- Cuffia (on/off)

#### Tasti funzione programmabili con LED

Default: Linea

- Lampeggia rapidamente: Chiamata in arrivo
- Luce costante: Chiamata in corso
- Lampeggia lentamente: Chiamata in attesa

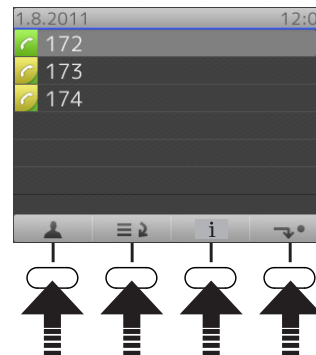

#### Simboli delle funzioni disponibili in base al contesto

- Selezionare l'identità per chiamate in uscita (comprese le identità non inattive)
- Elenchi chiamate (Perse, Entranti [in ingresso], in Uscenti [in uscita])
- Inoltro di tutte chiamate (on/off)
- Informazioni attuali (inoltro di chiamate attivo, chiamate perse, password non impostata, etc.)

Premere il tasto funzione sotto il simbolo per attivare la funzione indicata dal simbolo, avviare un'azione etc.

- Confermare/salvare azioni e dati inseriti
- Dalla schermata inattivo: **Ripetizione chiamata**
- Annullare azioni e dati inseriti
- Chiamata perse: Spegnerlo il LED

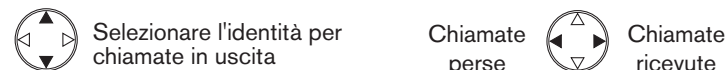

#### Tasti funzioni dedicati / preconfigurati:







- Tasto "Nuovi messaggi" con LED
  - Luce costante: Nuovo messaggio
  - Premere il tasto per ascoltare il messaggio
- Funzione "non disturbare" on/off
- Rubrica
- Menu Impostazioni
- Trasferimento
- Mettere le telefonate in attesa



#### Tasto asterisco

- In modalità inserimento:
  - Premuto per 1 secondo: passaggio dalla modalità di inserimento numerica alle lettere minuscole e maiuscole
  - Premere brevemente per inserire l'asterisco (\*)
- Premuto per 3 secondi in modalità inattivo: **Bloccare/sbloccare la tastiera**

**Tasto cancelletto** #: Modo "Rescue" (inizializzazione e registrazione con TFTP)

## Menu impostazioni



- Premere 
- Selezionare un sottomenu o un'impostazione: Premere il tasto numerico corrispondente ,  etc.
- Selezionare un'impostazione: /
- Salvare la modifica 

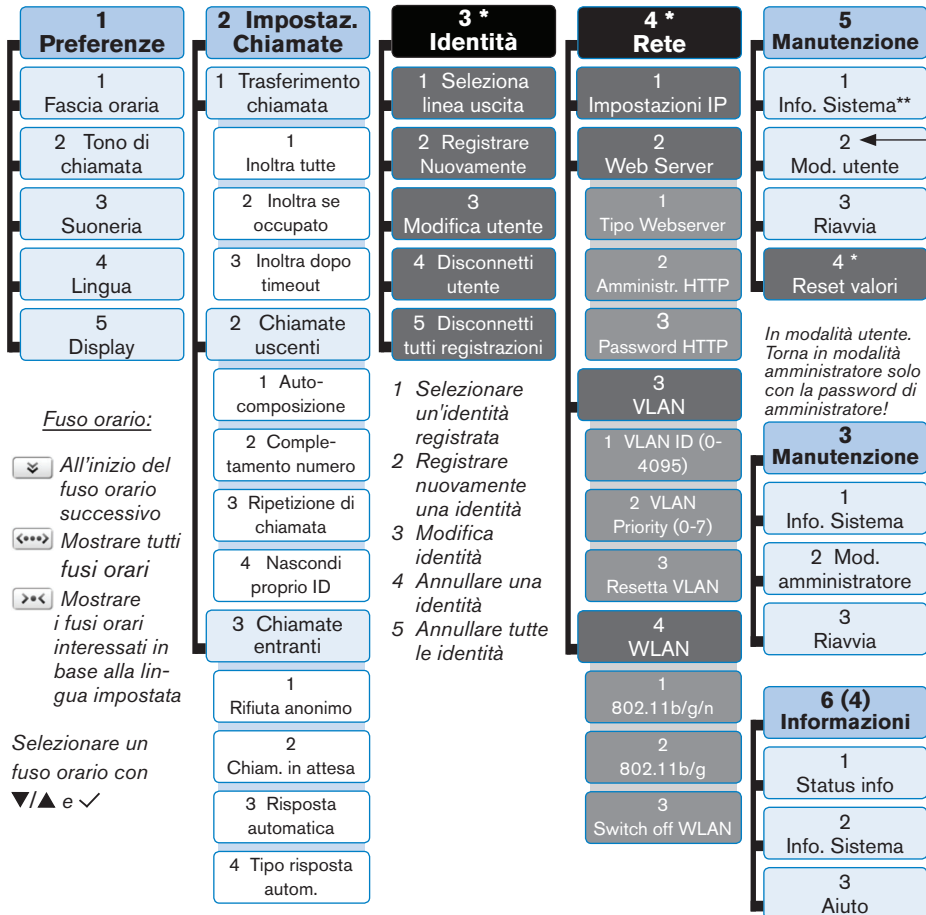

- Impostazione con (Acceso)/(Spento) [=on/off] o (Sì)/(No): Modificare e salvare simultaneamente con 
- Tornare alla schermata precedente: 
- Tornare alla schermata inattivo: 

Modalità amministratore. Premendo il tasto 2 il telefono torna in modalità utente:



### Fuso orario:

-  All'inizio del fuso orario successivo
-  Mostrare tutti fusi orari
-  Mostrare i fusi orari interessati in base alla lingua impostata

Selezionare un fuso orario con / e 

\* I sottomenu e le impostazioni in **grigio e nero** non sono disponibili in modalità utente. La modalità amministratore è impostata di default. La password di amministratore è 0000 (4 x zero).

\*\* Info Sistema: Versione de Firmware, **indirizzo IP**, indirizzo MAC, memoria totale + libera

## L'interfaccia Web del telefono

1. Trovare l'indirizzo IP:  > 6 Informazioni > Info sistema, per esempio 192.168.10.115.
2. Aprire il browser web del vostro PC e digitare http:// seguito dall'indirizzo IP nella barra degli indirizzi. Premere Invio per aprire l'interfaccia Web del telefono.
3. Cliccare su una voce del menu per aprire la pagina relativa.

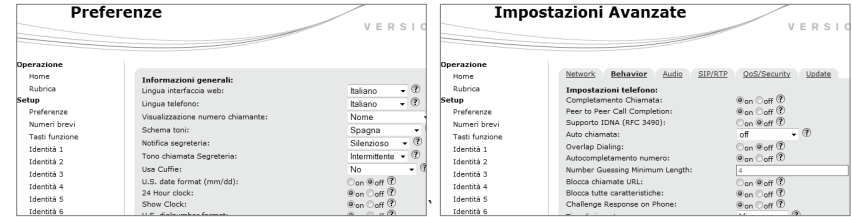

4. Alcune pagine contengono più sottosezioni. Per accedervi basta cliccare sulla rispettiva scheda. Il carattere è in **grassetto** per la scheda attiva.
5. Ricordare di premere sempre "Applica" prima di cliccare su un'altra voce del menu o di chiudere l'interfaccia web se volete che le modifiche vengano applicate.
6. Dopo aver cliccato su "Applica" appare in alto sulla pagina il pulsante "Salva". Cliccando su tale pulsante le modifiche apportate verranno salvate in modo permanente. Le modifiche non salvate andranno perse in caso di black-out o scollegamento del telefono dalla rete elettrica.

### Formato ora

Interfaccia Web > Preferenze > Informazioni generali > 24 Hour clock:  
 On: Formato 24 ore, 00:00 - 23:59  
 Off: Formato 12 ore AM/PM, 0:00 A - 11:59 P

### Formato della data

Interfaccia Web > Preferenze > Informazioni generali > US date format (mm/dd).  
 Esempio: il 3 marzo 2010.  
 On: 3/8/2010; Off: 8.3.2010

### Impostazioni identità/Account

Interfaccia Web > Identità 1-12 > Login. Vedi "Inizializzazione e registrazione" a la pagina 41 per le dati obbligatori.

### Tasti funzione

Configurare i tasti funzione: Interfaccia web del telefono > Tasti funzione. Modificare le impostazioni > Salvare. P. es.: Dedicare i tasti P5 e P6 alla funzione "Extension" per gli interni 154 e 4403.

| Contesto | Tipo      | Numero      | Short Text |        |
|----------|-----------|-------------|------------|--------|
| Active   | Extension | < sip:154@  | admin      | P5 (5) |
| 4400@    | Extension | < sip:4403@ | Jane       | P6 (6) |

## Usare il telefono

### Selezionare un'identità per effettuare una chiamata

dallo display inattivo: ◀▶

### Chiamare

- Digitare il numero e sganciare la cornetta o
- Sganciare la cornetta, digitare il numero e premere ✓ o
- , digitare il numero, ✓.

### Composizione rapida

Impostazione: Interfaccia Web > Composizione rapida (Speed Dial/Numeri brevi). Inserire un numero completo di prefisso (nazionale e internazionale) nel campo di testo del tasto per la composizione rapida. **NON AGGIUNGERE UN NOME PRIMA O DOPO IL NUMERO!** Esempio: Immettere il numero (911) 555-1234 come 9115551234.

Chiamare i numeri speed dial: Inserire il numero (0-30) o il carattere speciale # o \* assegnato al numero di telefono e premere ✓.

### Numeri d'emergenza





Possono essere chiamati anche con la tastiera bloccata. Predifinito: "911", "112", "110", "999".

Impostazione sull'interfaccia web: Interfaccia Web > Preferenze > Blocca Keyboard > Numeri d'emergenza (separati tra loro con uno spazio). Digitare ogni numero senza spazi tra le cifre, separare i vari numeri con uno spazio vuoto tra di loro. Esempio: 911 112 110 999.

### Accettare le chiamate

- Usando la cornetta: Sganciare la cornetta
- Usando una cuffia: Premere ✓ o il tasto linea lampeggiante
- Usando il vivavoce: Premere 

### Mettere le telefonate in corso in attesa

Premere . Il LED lampeggia lentamente. Riprendere la chiamata: Premere nuovamente il tasto . È possibile recuperare una chiamate con più chiamate in attesa: Selezionare chiamata con  /  > premere ✓.

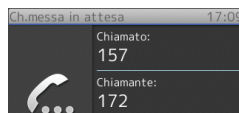



### Conferenza (3-5 partecipanti)

1. Primo partecipante: 157 (tu). Secondo partecipante: Il chiamante 157. Metterla in attesa.

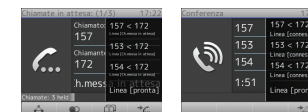
2. Chiamare il terzo partecipante (153). Metterlo in attesa. Chiamare il quarto partecipante (154). Avviare la conferenza: Premere .





3. Interrompere la conferenza e mettere i partecipanti in attesa: Premere . È possibile recuperare una chiamate messe in attesa: Selezionare chiamata con  /  e premere ✓.



4. Avviare la conferenza di nuovo: Premere .

## Trasferimento

### Annunciate



Mettere le chiamate in attesa  > Digitare il numero di telefono a cui inoltrare la chiamata. Annunciare la chiamata > Se il terzo desidera accettare la telefonata: Premere  e ✓.

### Trasferimento diretto (senza annunciare la chiamata)





Quando il telefono squilla o durante la telefonata in corso: Premere  > Digitare il numero di telefono a cui inoltrare la chiamata > premere ✓.

## Inoltro di chiamate





1. Tutte le chiamate in arrivo

- Attivare:  > Trasn. Interno > Digitare il numero di telefono a cui inoltrare la chiamata > ✓
- Disattivare: 

2. Se occupato

- Attivare:  > 2 Impostaz. Ch. > 1 Trasferimento chiamata > 2 Inoltra se occupato > 2 Trasn. Interno > digitare il numero di telefono a cui inoltrare la chiamata > ✓ > 1 Attivare inoltra [No: Premere ] ⇒ Sì) > X per 2 secondi
- Disattivare:  > 2 Impostaz. Ch. > 1 Trasferimento chiamata > 2 Inoltra se occupato > 1 Attivare inoltra [Si: Premere ] ⇒ No] > X per 2 secondi

3. Dopo timeout (senza risposta)

- Attivare:  > 2 Impostaz. Ch. > 1 Trasferimento chiamata > 3 Inoltra dopo timeout > 2 Trasn. Interno > digitare il numero di telefono a cui inoltrare la chiamata > ✓ > 3 Orario Deviazione > digitare il numero di secondi > ✓ > 1 Attivare inoltra [No: Premere ] ⇒ Sì) > X per 2 secondi
- Disattivare:  > 2 Impostaz. Ch. > 1 Trasferimento chiamata > 3 Inoltra dopo timeout > 1 Attivare inoltra [Si: Premere ] ⇒ No] > X per 2 secondi



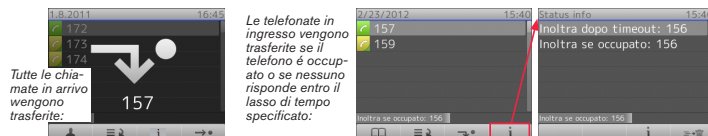

## Elenchi delle chiamate

- Per aprire: Premere
- Selezionare un elenco (Lista chiamate: Perse, Entranti [in ingresso], Uscenti [in uscita]) con: ▲▼ + ✓
- Selezionare un numero di telefono dalla lista: ▲▼. Comporre: Premere ✓. Visualizzare i dettagli di chiamata: . Cancellare la chiamata: . Cancellare la lista: .

## Rubrica

- Per aprire: Premere
- Per scorrere: ▲▼.
- Andare direttamente al <Nuovo inserimen>: ▲.
- Chiama il numero: ✓. Cancellare il numero: . Visualizzare i dettagli: . Modifica i dati attuali: ✓.

## Risoluzione dei problemi

### Riavvio

> 5 Manutenzione > 3 Riavvia > ✓ > "Riavviare?" > ✓

### Riavvio forzato

Staccare il telefono dalla presa di corrente. Ricollegare il telefono alla corrente dopo alcuni secondi.

**Non staccare dalla corrente quando il telefono si sta riavviando !**

### Reimpostare i valori di fabbrica

> 5 Manutenzione > 4 Reset valori > digitare la password di amministratore > ✓

**Tutte le impostazioni modificate andranno perse!**

### Aggiornamento TFTP

Se non si riesce più a rendere operativo il telefono (password di amministratore persa etc). Come fare: [http://wiki.snom.com/Firmware/Update/TFTP\\_Update/en](http://wiki.snom.com/Firmware/Update/TFTP_Update/en).

**Tutte le impostazioni modificate andranno perse!**

Esta es la Guía de inicio rápido para la instalación, configuración y uso del snom 760. Para más información, consulte el manual en nuestra página web <http://wiki.snom.com>.

## Propiedad intelectual, Marcas registradas, GNU General Public License, Exención de responsabilidad

© 2012 snom technology Aktiengesellschaft

Todos los derechos reservados.

snom, los nombres de los productos snom, y los logos de snom son marcas comerciales propiedad de snom technology AG. Los demás nombres de productos y empresas son propiedad de sus respectivos propietarios.

snom technology AG se reserva el derecho de revisar y modificar este documento en cualquier momento, sin obligación de notificar estas revisiones o modificaciones por adelantado o con posterioridad a su realización.

Los textos, imágenes e ilustraciones, y su presentación en este documento, están sujetos a la protección de copyright y otros derechos legales internacionales. Su uso, reproducción y transmisión a terceros sin permiso expreso por escrito puede dar lugar al inicio de procedimientos legales en los tribunales penales y civiles.

Aunque se han tomado todas las precauciones posibles en la compilación y presentación de la información de este documento, los datos en los que se basa pueden haber cambiado con el tiempo. snom, por lo tanto, renuncia a cualquier garantía y responsabilidad respecto a la precisión, exhaustividad y vigencia actual de la información publicada, excepto en el caso de intencionalidad o negligencia grave por parte de snom cuando se deriven responsabilidades de acuerdo con las disposiciones legales vinculantes.

Nuestro firmware incluye código fuente que puede ser usado y modificado por cualquier persona bajo la licencia pública GNU (GPL) (ver la página 59), siempre que, a su vez, lo ponga a disposición de cualquier otra persona que tenga el mismo acuerdo de licencia. Acceda a <http://www.snom.com/de/support/download/gpl-quellcode/> para obtener la licencia GPL original y el código fuente de los componentes con licencia en virtud de la GPL y utilizados en productos snom.

## Información importante

Lea las instrucciones sobre seguridad telefónica y reciclaje del teléfono, y sobre cómo configurar y utilizar el teléfono antes de usarlo, y ofrézcalas igualmente a otros usuarios para que las lean o se informen de su contenido. Conserve este manual y no entregue el teléfono a terceros sin el mismo.

## Seguridad

Siga las instrucciones de este manual y otra documentación aplicable del dispositivo.

- Evite poner los cables del teléfono de modo que otras personas puedan tropezar con el mismo. No coloque los cables del teléfono de forma que pueda verse sometido a presiones mecánicas, ya que eso podría dañar los cables. Si los cables o el enchufe están dañados, desconecte el teléfono y contacte con personal de servicio cualificado.

- Este dispositivo es **solamente para uso en interiores**. No debe instalarse en el exterior.
- No instale el teléfono en lugares con humedad elevada (por ejemplo, en baños, lavaderos, o sótanos húmedos). No sumerja el teléfono en agua ni derrame o vierta líquidos de ningún tipo sobre el teléfono.
- No instale el teléfono cerca de lugares con riesgo de explosión (talleres de pintura, por ejemplo). No use el teléfono si huele a gas o a otros vapores que puedan ser explosivos.
- No use el teléfono durante una tormenta; los rayos que impacten en la red eléctrica pueden provocar descargas eléctricas.
- Atención:** El auricular contiene un imán y puede atraer pequeños objetos peligrosos, como agujas o alfileres. Antes de utilizarlo, asegúrese de que no se ha adherido ningún objeto.

### Cumplimiento de los requisitos SELV (Tensión Extra-Baja de Seguridad)

Las condiciones de seguridad de las conexiones de entrada/salida cumplen con los requisitos SELV.

**Atención:** Para evitar descargas eléctricas, no conecte circuitos de tensión extra baja (SELV) a circuitos de tensión de red telefónica (TNV). Los puertos LAN contienen circuitos SELV, los puertos PSTN contienen circuitos TNV. Algunos puertos LAN y PSTN utilizan conectores RJ-45 (8P8C). Tome precauciones cuando conecte los cables.

### Cumplimiento con la normativa

Este teléfono tiene certificación CE y FCC, y cumple con los estándares de salud, seguridad y medioambientales europeos y de Estados Unidos.



La apertura, cambio, o modificación no autorizadas del teléfono provocarán la cancelación de la garantía, y también pueden causar la pérdida de las certificaciones CE y FCC. En caso de avería, contacte con personal de servicio autorizado, con su vendedor o con snom.

- Seguridad:** IEC 60950-1:2007
- Certificados:** FCC Class B, Indicación CE
- Alimentación:** PoE (Power over Ethernet) IEEE 802.3af, Clase 2 o 5 V DC
- Ethernet:** 2x IEEE 802.3 Conmutador 1 Gigabit switch
- 1 x LAN, 1 x PC:** RJ45
- Consumo eléctrico:** 4 - 6 Watts (sin periféricos USB)

### Eliminación



Este teléfono está sujeto a la Directriz Europea 2002/96/EC, y no puede ser eliminado con los residuos domésticos generales.

Si no sabe dónde puede desechar el dispositivo al final de su vida útil, contacte con su municipio, su proveedor de gestión de residuos local, o su vendedor.

### Limpeza

Use un paño antiestática. No utilice agua ni productos de limpieza, ya que podrían dañar la superficie o los componentes electrónicos del aparato.

### Instalación y conexión del teléfono: Ver las páginas 2-3

### Inicialización y registro del teléfono

**Importante:** Necesitará la información de registro que le haya proporcionado su proveedor de internet o su administrador de red, normalmente el número de teléfono, la extensión, la contraseña y el registro.

Cuando haya instalado el teléfono y lo haya conectado a la red como se indica en las páginas 2-3, el teléfono empezará a inicializar.

Normalmente la inicialización es totalmente automática y se realiza a través del protocolo DHCP. Si su red no admite DHCP, debe obtener la dirección IP, la máscara de red, el IP de la puerta de enlace y el servidor DNS de su proveedor de internet o su administrador de red e introducirlos manualmente cuando se le solicite en la pantalla.

Cuando se le indique, seleccione una opción con ▼/☑ y guarde los cambios con ✓.

- Idioma. El idioma por defecto es inglés.
- Huso horario
- Tono de marcado
- La pantalla mostrará: "Welcome". Pulse cualquier tecla para registrar.
- Introduzca la cuenta/el número de teléfono y pulse ✓.
- Introduzca el registro (Registrar) y pulse ✓.
- Introduzca la contraseña y pulse ✓. La pantalla mostrará el símbolo verde:

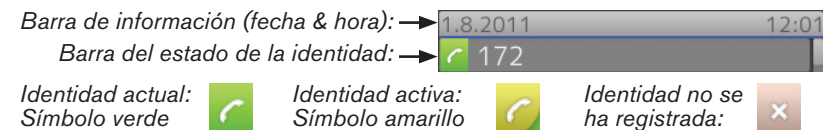

### Introducir letras, números y caracteres especiales

Pulse cualquier tecla.

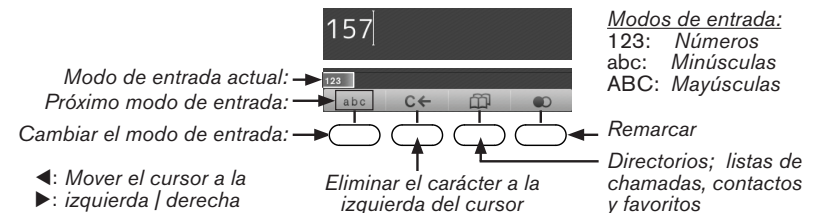

### Letras, caracteres especiales y símbolos

En modo letras pulse la tecla una vez o varias veces rápidamente, con una breve pausa después de cada letra.

La tecla "0": 1x = espacio (" "); 2x = guión bajo ("\_"); 3x = 0

La tecla "1": . + @ 1 : , ? ! - \_ / \ ( ) ; & % \* # <=> \$ [ ]

Ejemplos: 1x = "."; 2x = "+"; 3x = "@"; 4x = "1"; 5x = ":"; 6x = ":",

Teclas "2"- "9": Letras con signos diacríticos en modos minúsculas y mayúsculas. Pulse la tecla con el letra una vez o varias veces rápidamente. Por ejemplo: En Español, pulse la tecla "2" cuatro veces para introducir il letra "á". Letras disponibles dependiendo del idioma seleccionada.

### De un vistazo

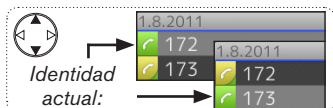

#### LED indicador de llamada

- Parpadeo rápido: Llamada entrante
- Luz fija: Llamada en curso o
- Llamadas perdidas. Apagalo: Pulse X.

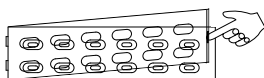
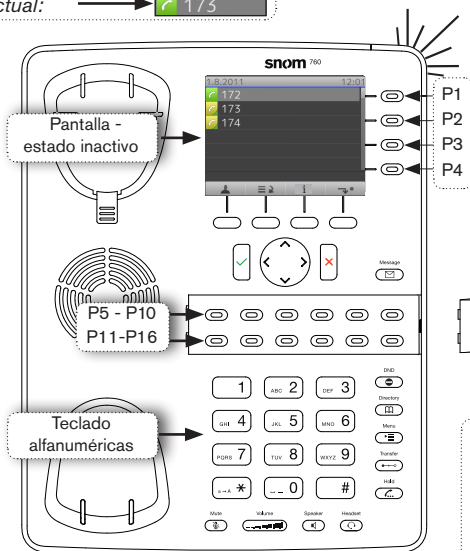

#### Teclas de función con LEDs, libremente programables

Configuración estándar de fábrica: Línea

- Parpadeo rápido: Llamada entrante
- Luz fija: Llamada en curso
- Parpadeo lento: Llamada en espera

Tecla almohadilla [ # ]: Restablecer valores de fábrica con TFTP

#### Teclas de audio

- [ Speaker icon ] Ajuste de volumen
- [ Mic icon ] Micrófono (encendido/apagado)
- [ Speaker icon ] Altavoz (encendido/apagado)
- [ Headset icon ] Auriculares (encendido/apagado)

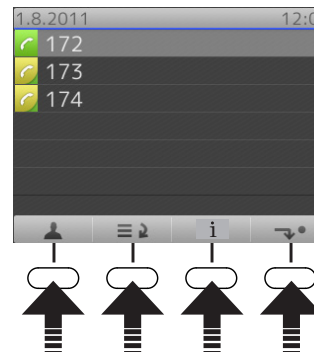

#### Símbolos de las funciones disponibles en este contexto particular

- [ Person icon ] Seleccionar una identidad (identidades inactivas incluso) para la llamada saliente
- [ List icon ] Listas de llam. (perdidas, recibidas, marcadas)
- [ Forward icon ] Desvío de todas las llamadas entrantes (activar/desactivar)
- [ Info icon ] Información actual (desvío de llamadas activo, llamadas perdidas, contraseña HTTP no configurada, etc.)

Pulse la tecla de función debajo del símbolo de contexto para activar la función indicada en el símbolo, iniciar una acción etc.

- Confirmar/guardar acciones y entradas
- Desde la pantalla inactiva: **Marcar nuevamente**
- Cancelar acciones y entradas
- Apagar LED después de llamada perdida

Seleccionar una identidad activa para la llamada saliente

Llamadas perdidas Llamadas recibidas

#### Teclas funciones preprogramada/programable:

- [ Mail icon ] Tecla "Mensaje nuevo" con LED
  - Luz fija: Mensaje nuevo
  - Pulse la tecla para apagarlo
- [ No disturb icon ] Función "no molestar" encendido/apagado
- [ Directory icon ] Directorio telefónico
- [ Menu icon ] Menú Ajustes
- [ Transfer icon ] Transferencia
- [ Hold icon ] Poner la llamada en curso en espera

#### Tecla de asterisco [ \* ]

- En modo "Edición":
  - Pulse [ \* ] durante un segundo para cambiar el modo de entrada de datos: números, minúsculas y mayúsculas.
  - Pulse [ \* ] brevemente para introducir el asterisco (\*)
- Desde la pantalla inactiva: Pulse durante tres segundos para **bloquear/desbloquear el teclado**

## Menú Ajustes

- Pulse el tecla
- Seleccionar un submenú o un ajuste: Pulse el tecla alfanumérico correspondiente etc.
- Seleccionar un ajuste: ▼/▲
- Guardar tus modificaciones: ✓

- Ajustes con (Encendido)/(Apagado) o (No)/(Sí): Modificar y guardar simultáneamente con ✓
- Volver a la pantalla precedente: ✕
- Volver a la pantalla inactiva:

El menú Mantenimiento en modo administrador:

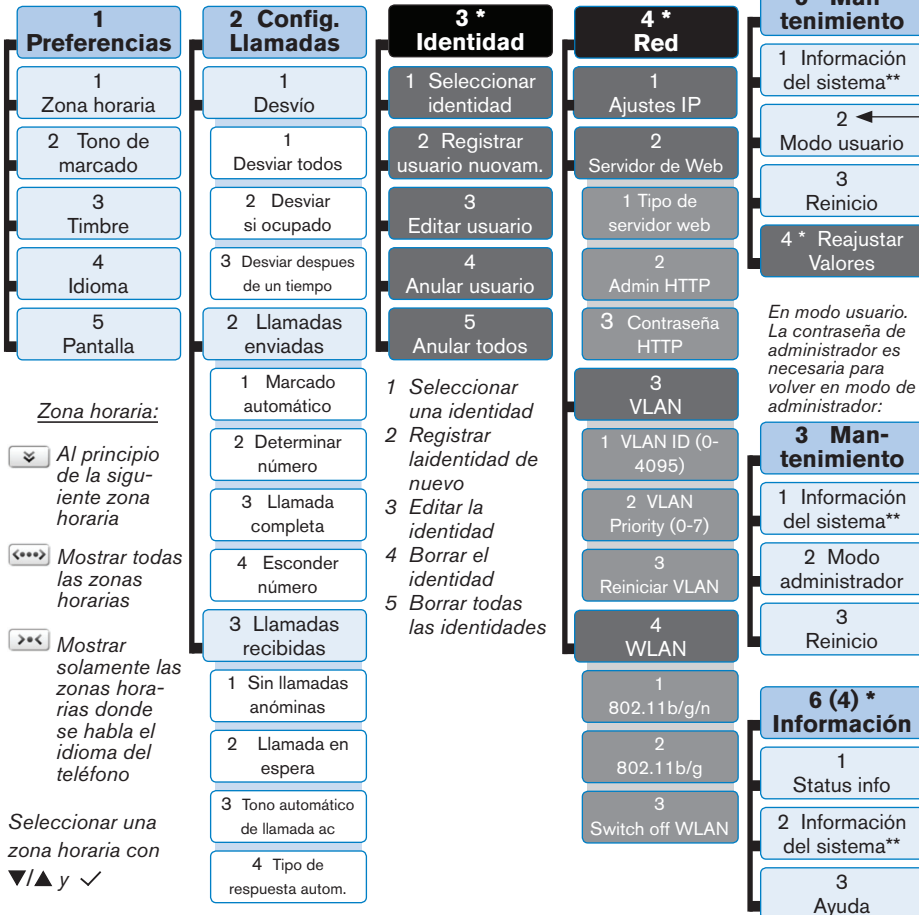

\* Los submenús y los ajustes en las casillas gris y negras no son accesibles en modo de usuario. El valor predeterminado es el modo de administrador. La contraseña de administrador predeterminada: 0000 (4 x cero).

\*\* Información del sistema: Versión del firmware, dirección IP y MAC, memoria

## La interfaz web del teléfono

1. Obtenga la dirección IP del teléfono: > 6 Información > 2 Información del sistema, por ejemplo 192.168.10.115.
2. Abra el navegador de su PC y teclee http:// seguido de la dirección IP en la barra de direcciones. Pulse la tecla Enter para abrir la interfaz web del teléfono.
3. Haga clic en un elemento del menú a la izquierda para abrir la página.



4. Si una ventana contiene diversas páginas, haga clic en la pestaña de la parte superior de la página para abrirla. La fuente de los caracteres de la pestaña activa está en **negrita**.
5. Los cambios que realice no tendrán efecto hasta que haga clic en "Aplicar". Se perderán todos los cambios si abre otra página de la interfaz web o si cierra la interfaz web sin haber pulsado antes "Aplicar".
6. Cuando haga clic en "Aplicar" aparecerá la opción "Guardar" en la parte superior de la página. Haga clic en "Guardar" para guardar los cambios de forma permanente. Los cambios que no se hayan grabado se perderán si se produce un fallo de alimentación o el teléfono se desconecta de la red eléctrica.

### Formato de hora

Interfaz Web > Preferencias > Información General > 24 Hour clock:  
 Encendido: Formato 24 horas, 00:00 - 23:59  
 Apagado: Formato 12 horas AM/PM, 0:00 A - 11:59 P

### Formato de fecha

Interfaz Web > Preferencias > Información General > US date format (mm/dd):  
 Encendido o apagado. Ejemplo: 8 de marzo 2010:  
 Encendido - 3/8/2010; Apagado - 8.3.2010

### Teclas de funciones

Configurar las teclas de funciones: Interfaz web del teléfono > Teclas de funciones. Modificar los ajustes > Salvar. P. ej.: Programar la función "Extension" para las conexiones adicionales 154 y 4403 en las teclas de funciones P5 y P6.

| Context | Type      | Número     | Short Text |        |
|---------|-----------|------------|------------|--------|
| Active  | Extensión | <sip:154@  | admin      | P5 (5) |
| 4400@   | Extensión | <sip:4403@ | Jane       | P6 (6) |

## Configurar y modificar las identidades (cuentas)

Interfaz Web > Identidad 1-12 > Login. Ver "Inicialización y registro del teléfono" a la página 51 por la información necesaria.

## Uso del teléfono

### Realizar llamadas

- Introduzca el número y descuelgue el auricular, o
- Descuelgue el auricular, introduzca el número y pulse ✓, o
- , introduzca el número, ✓.

### Marcación rápida

Configuración: Interfaz web > Discado Veloz. Introduzca el número de teléfono con cualquier prefijo necesario en el campo de texto en un número o carácter especial. **NO AÑADA UN NOMBRE ANTES NI DESPUÉS DEL NÚMERO!** Ejemplo: Introduzca el número (911) 555-1234 como 9115551234.



Cómo utilizar el marcado rápido: Introduzca el número o \* o # en el teclado alfanumérico y pulse ✓.

### Números de emergencia





Pueden marcarse aunque el teclado esté bloqueado. Preajustado: "911", "112", "110", "999".

Configuración en la interfaz web: Interfaz web > Preferencias > Lock Keyboard > Emergency Numbers (space separated). Teclee cada número sin espacios entre los dígitos, separe los números de teléfono con un espacio vacío en medio. Ejemplo: 911 112 110 999.

### Aceptar llamadas

- Con el auricular: Descuelgue el auricular
- Con un auriculares : Pulse ✓ o la tecla de línea que parpadee
- Con el altavoz: Pulse 

### Poner la llamada en curso en espera

Pulse . El LED empezará a parpadear lentamente. Vuelva a pulsar  para retomar la llamada. Si tiene más de una llamada en espera, seleccione un participante con  /  y pulse ✓ para hablarle.

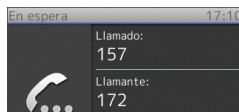





### Conferencia (hasta 5 participantes)

1. Su número de teléfono: 157. Ponga la primera llamada (Jane Doe) en espera.

2. Llame al segundo participante (158). Pongalo en espera. Llame al tercero participante (154). Pulse  para iniciar la conferencia.





3. Pulse  para parar la conferencia y poner a los participantes en espera. Con más de una llamada en espera: Seleccione un participante con  /  y pulse ✓ para hablarle exclusivamente.
4. Retomar la conferencia: Pulse .



## Transferencia de llamadas











### Transferencia asistida

Pulse  para poner la llamada en espera > Marque el número al que desea transferir la llamada. Si el destinatario desea aceptar la llamada, pulse  y ✓.

### Transferencia directa (sin anunciar la llamada)

Cuando una llamada está sonando o con una llamada en la línea: Pulse  > marque el número al que se desea transferir la llamada > pulse ✓.

## Desvío de llamadas

1. Todas las llamadas entrantes.
  - Activar:  > Destino del desvío > introducir el número al que desviar la llamada > ✓.
  - Desactivar: 
2. Cuando la línea este ocupada.
  - Activar:  > 2 Config Llamada > 1 Desvío > 2 Desviar si ocupado > 2 Destino del desvío > introducir el número al que desviar la llamada > ✓ > 1 Activar desvío [No: Pulse ] ⇔ Si] > X durante 2 segundos
  - Desactivar:  > 2 Config Llamada > 1 Desvío > 2 Desviar si ocupado > 1 Activar desvío [Si: Pulse ] ⇔ No] > X durante 2 segundos
3. Si no responde a la llamada.
  - Activar:  > 2 Config Llamada > 1 Desvío > 3 Desvío despues de un tiempo > 2 Destino del desvío > introducir el número al que desviar la llamada > ✓ > 3 Hora de desvío > introducir el número de segundos tras los que se debe desviar la llamada > ✓ > 1 Activar desvío [No: Pulse ] ⇔ Si] > X durante 2 segundos
  - Desactivar:  > 2 Config Llamada > 1 Desvío > 3 Desvío despues de un tiempo > 1 Activar desvío [Si: Pulse ] ⇔ No] > X durante 2 segundos



Desvío de las llamadas entrantes cuando la línea este ocupada o si no responde a la llamada:

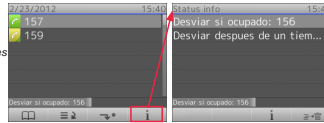

### Listas de llamadas

- Para abrir: Pulse
- Seleccionar una lista (Perdidas, Recibidas, Marcadas) con ▲▼ > ✓
- Seleccionar un número de teléfono de la lista: ▲▼. Pulse ✓ para marcar el numero, pulse para mostrar los detalles de la llamada, pulse para eliminar la entrada. Pulse para eliminar la lista.

### Directorio telefónico

- Para abrir la lista de entradas: Pulse
- Ir directamente a <Nueva entrada>, el ultimo elemento de la lista: p. Localice una entrada: pq.
- Marcar: ✓. Mostrar los detalles: . Editar el detalle actual: ✓. Eliminar la entrada: .

### Solución de problemas

#### Reinicio (Reboot)

> pulse Mantenimiento > pulse Reinicio > "Reiniciar?" > ✓

#### Reinicio físico

Desconecte el cable de alimentación del teléfono. Vuelva a conectar la alimentación pasados unos segundos.

**No desconecte el cable de alimentación mientras se está actualizando de Firmware !**

#### Restablecer valores de fábrica

> pulse Mantenimiento > pulse Reajustar valores > introducir la contraseña de administrador > ✓

**Toda la configuración se borrará !**

#### TFTP Update

Si no hay manera que el teléfono le funcione (contraseña de administrador perdida, etc.) ¿Cómo se hace: Ver [http://wiki.snom.com/Firmware/Update/TFTP\\_Update/en](http://wiki.snom.com/Firmware/Update/TFTP_Update/en).

**Toda la configuración se borrará !**

### COPYRIGHT NOTICE AND WARRANTY DISCLAIMER

I. Das Produkt enthält Software, die unter der GNU General Public License, Version 2, frei genutzt werden darf.

This Product contains Software applicable to GNU General Public License, Version 2 which can be used freely.

II. Im Verhältnis zu den Lizenzgebern der Software gilt der folgende Haftungsausschluss:

Towards the licensor of this Software the following liability is disclaimed:

This program is distributed in the hope that it will be useful, but WITHOUT ANY WARRANTY; without even the implied warranty of MERCHANTABILITY or FITNESS FOR A PARTICULAR PURPOSE. See the GNU General Public License for more details.

III.

Der Lizenztext der GPL lautet wie folgt:

The GNU General Public License is as follows:

GNU GENERAL PUBLIC LICENSE  
Version 2, June 1991

Copyright (C) 1989, 1991  
Free Software Foundation, Inc.  
59 Temple Place, Suite 330  
Boston, MA 02111-1307, USA

Everyone is permitted to copy and distribute verbatim copies of this license document, but changing it is not allowed.

Preamble

The licenses for most software are designed to take away your freedom to share and change it. By contrast, the GNU General Public License is intended to guarantee your freedom to share and change free software--to make sure the software is free for all its users. This General Public License applies to most of the Free Software Foundation's software and to any other program whose authors commit to using it. (Some other Free Software Foundation software is covered by the GNU

Library General Public License instead.) You can apply it to your programs, too.

When we speak of free software, we are referring to freedom, not price. Our General Public Licenses are designed to make sure that you have the freedom to distribute copies of free software (and charge for this service if you wish), that you receive source code or can get it if you want it, that you can change the software or use pieces of it in new free programs; and that you know you can do these things.

To protect your rights, we need to make restrictions that forbid anyone to deny you these rights or to ask you to surrender the rights. These restrictions translate to certain responsibilities for you if you distribute copies of the software, or if you modify it. For example, if you distribute copies of such a program, whether gratis or for a fee, you must give the recipients all the rights that you have. You must make sure that they, too, receive or can get the source code. And you must show them these terms so they know their rights.

We protect your rights with two steps: (1) copyright the software, and (2) offer you this license which gives you legal permission to copy, distribute and/or modify the software.

Also, for each author's protection and ours, we want to make certain that everyone understands that there is no warranty for this free software. If the software is modified by someone else and passed on, we want its recipients to know that what they have is not the original, so that any problems introduced by others will not reflect on the original authors' reputations.

Finally, any free program is threatened constantly by software patents. We wish to avoid the danger that redistributors of a free program will individually obtain patent licenses, in effect making the program proprietary. To prevent this, we have made it clear that any patent must be licensed for everyone's free use or not licensed at all.

The precise terms and conditions for copying, distribution and modification follow.

GNU GENERAL PUBLIC LICENSE  
TERMS AND CONDITIONS FOR COPYING,  
DISTRIBUTION AND MODIFICATION

0. This License applies to any program or other work which contains a notice placed by the copyright holder saying it may be distributed

under the terms of this General Public License. The „Program“, below, refers to any such program or work, and a „work based on the Program“ means either the Program or any derivative work under copyright law: that is to say, a work containing the Program or a portion of it, either verbatim or with modifications and/or translated into another language. (Hereinafter, translation is included without limitation in the term „modification.“) Each licensee is addressed as „you“.

Activities other than copying, distribution and modification are not covered by this License; they are outside its scope. The act of running the Program is not restricted, and the output from the Program is covered only if its contents constitute a work based on the Program (independent of having been made by running the Program). Whether that is true depends on what the Program does.

1. You may copy and distribute verbatim copies of the Program's source code as you receive it, in any medium, provided that you conspicuously and appropriately publish on each copy an appropriate copyright notice and disclaimer of warranty; keep intact all the notices that refer to this License and to the absence of any warranty; and give any other recipients of the Program a copy of this License along with the Program.

You may charge a fee for the physical act of transferring a copy, and you may at your option offer warranty protection in exchange for a fee.

2. You may modify your copy or copies of the Program or any portion of it, thus forming a work based on the Program, and copy and distribute such modifications or work under the terms of Section 1 above, provided that you also meet all of these conditions:

- a) You must cause the modified files to carry prominent notices stating that you changed the files and the date of any change.
- b) You must cause any work that you distribute or publish, that in whole or in part contains or is derived from the Program or any part thereof, to be licensed as a whole at no charge to all third parties under the terms of this License.
- c) If the modified program normally reads commands interactively when run, you must

cause it, when started running for such interactive use in the most ordinary way, to print or display an announcement including an appropriate copyright notice and a notice that there is no warranty (or else, saying that you provide a warranty) and that users may redistribute the program under these conditions, and telling the user how to view a copy of this License. (Exception: if the Program itself is interactive but does not normally print such an announcement, your work based on the Program is not required to print an announcement.)

These requirements apply to the modified work as a whole. If identifiable sections of that work are not derived from the Program, and can be reasonably considered independent and separate works in themselves, then this License, and its terms, do not apply to those sections when you distribute them as separate works. But when you distribute the same sections as part of a whole which is a work based on the Program, the distribution of the whole must be on the terms of this License, whose permissions for other licensees extend to the entire whole, and thus to each and every part regardless of who wrote it.

Thus, it is not the intent of this section to claim rights or contest your rights to work written entirely by you; rather, the intent is to exercise the right to control the distribution of derivative or collective works based on the Program. In addition, mere aggregation of another work not based on the Program with the Program (or with a work based on the Program) on a volume of a storage or distribution medium does not bring the other work under the scope of this License.

3. You may copy and distribute the Program (or a work based on it, under Section 2) in object code or executable form under the terms of Sections 1 and 2 above provided that you also do one of the following:
  - a) Accompany it with the complete corresponding machine-readable source code, which must be distributed under the terms of Sections 1 and 2 above on a medium customarily used for software interchange; or,
  - b) Accompany it with a written offer, valid for at least three years, to give any third party, for a charge no more than your cost of physically

performing source distribution, a complete machine-readable copy of the corresponding source code, to be distributed under the terms of Sections 1 and 2 above on a medium customarily used for software interchange; or,

- c) Accompany it with the information you received as to the offer to distribute corresponding source code. (This alternative is allowed only for noncommercial distribution and only if you received the program in object code or executable form with such an offer, in accord with Subsection b above.)

The source code for a work means the preferred form of the work for making modifications to it. For an executable work, complete source code means all the source code for all modules it contains, plus any associated interface definition files, plus the scripts used to control compilation and installation of the executable. However, as a special exception, the source code distributed need not include anything that is normally distributed (in either source or binary form) with the major components (compiler, kernel, and so on) of the operating system on which the executable runs, unless that component itself accompanies the executable.

If distribution of executable or object code is made by offering access to copy from a designated place, then offering equivalent access to copy the source code from the same place counts as distribution of the source code, even though third parties are not compelled to copy the source along with the object code.

4. You may not copy, modify, sublicense, or distribute the Program except as expressly provided under this License. Any attempt otherwise to copy, modify, sublicense or distribute the Program is void, and will automatically terminate your rights under this License. However, parties who have received copies, or rights, from you under this License will not have their licenses terminated so long as such parties remain in full compliance.
5. You are not required to accept this License, since you have not signed it. However, nothing else grants you permission to modify or distribute the Program or its derivative works. These actions are prohibited by law if you do not accept this License. Therefore, by modifying or distributing the Program (or any work based

on the Program), you indicate your acceptance of this License to do so, and all its terms and conditions for copying, distributing or modifying the Program or works based on it.

6. Each time you redistribute the Program (or any work based on the Program), the recipient automatically receives a license from the original licensor to copy, distribute or modify the Program subject to these terms and conditions. You may not impose any further restrictions on the recipients' exercise of the rights granted herein. You are not responsible for enforcing compliance by third parties to this License.

7. If, as a consequence of a court judgment or allegation of patent infringement or for any other reason (not limited to patent issues), conditions are imposed on you (whether by court order, agreement or otherwise) that contradict the conditions of this License, they do not excuse you from the conditions of this License. If you cannot distribute so as to satisfy simultaneously your obligations under this License and any other pertinent obligations, then as a consequence you may not distribute the Program at all. For example, if a patent license would not permit royalty-free redistribution of the Program by all those who receive copies directly or indirectly through you, then the only way you could satisfy both it and this License would be to refrain entirely from distribution of the Program.

If any portion of this section is held invalid or unenforceable under any particular circumstance, the balance of the section is intended to apply and the section as a whole is intended to apply in other circumstances.

It is not the purpose of this section to induce you to infringe any patents or other property right claims or to contest validity of any such claims; this section has the sole purpose of protecting the integrity of the free software distribution system, which is implemented by public license practices. Many people have made generous contributions to the wide range of software distributed through that system in reliance on consistent application of that system; it is up to the author/donor to decide if he or she is willing to distribute software through any other system and a licensee cannot impose that choice. This section is intended to make thoroughly clear what is believed to be a consequence of the rest of this License.

8. If the distribution and/or use of the Program is restricted in certain countries either by patents or by copyrighted interfaces, the original copyright holder who places the Program under this License may add an explicit geographical distribution limitation excluding those countries, so that distribution is permitted only in or among countries not thus excluded. In such case, this License incorporates the limitation as if written in the body of this License.

9. The Free Software Foundation may publish revised and/or new versions of the General Public License from time to time. Such new versions will be similar in spirit to the present version, but may differ in detail to address new problems or concerns. Each version is given a distinguishing version number. If the Program specifies a version number of this License which applies to it and „any later version“, you have the option of following the terms and conditions either of that version or of any later version published by the Free Software Foundation. If the Program does not specify a version number of this License, you may choose any version ever published by the Free Software Foundation.

10. If you wish to incorporate parts of the Program into other free programs whose distribution conditions are different, write to the author to ask for permission. For software which is copyrighted by the Free Software Foundation, write to the Free Software Foundation; we sometimes make exceptions for this. Our decision will be guided by the two goals of preserving the free status of all derivatives of our free software and of promoting the sharing and reuse of software generally.

#### NO WARRANTY

11. BECAUSE THE PROGRAM IS LICENSED FREE OF CHARGE, THERE IS NO WARRANTY FOR THE PROGRAM, TO THE EXTENT PERMITTED BY APPLICABLE LAW. EXCEPT WHEN OTHERWISE STATED IN WRITING THE COPYRIGHT HOLDERS AND/OR OTHER PARTIES PROVIDE THE PROGRAM „AS IS“ WITHOUT WARRANTY OF ANY KIND, EITHER EXPRESSED OR IMPLIED, INCLUDING, BUT NOT LIMITED TO, THE IMPLIED WARRANTIES OF MERCHANTABILITY AND FITNESS FOR A PARTICULAR PURPOSE. THE ENTIRE RISK AS TO THE QUALITY AND PERFORMANCE

OF THE PROGRAM IS WITH YOU. SHOULD THE PROGRAM PROVE DEFECTIVE, YOU ASSUME THE COST OF ALL NECESSARY SERVICING, REPAIR OR CORRECTION.

12. IN NO EVENT UNLESS REQUIRED BY APPLICABLE LAW OR AGREED TO IN WRITING WILL ANY COPYRIGHT HOLDER, OR ANY OTHER PARTY WHO MAY MODIFY AND/OR REDISTRIBUTE THE PROGRAM AS PERMITTED ABOVE, BE LIABLE TO YOU FOR DAMAGES, INCLUDING ANY GENERAL, SPECIAL, INCIDENTAL OR CONSEQUENTIAL DAMAGES ARISING OUT OF THE USE OR INABILITY TO USE THE PROGRAM (INCLUDING BUT NOT LIMITED TO LOSS OF DATA OR DATA BEING RENDERED INACCURATE OR LOSSES SUSTAINED BY YOU OR THIRD PARTIES OR A FAILURE OF THE PROGRAM TO OPERATE WITH ANY OTHER PROGRAMS), EVEN IF SUCH HOLDER OR OTHER PARTY HAS BEEN ADVISED OF THE POSSIBILITY OF SUCH DAMAGES.

#### END OF TERMS AND CONDITIONS

##### How to Apply These Terms to Your New Programs

If you develop a new program, and you want it to be of the greatest possible use to the public, the best way to achieve this is to make it free software which everyone can redistribute and change under these terms.

To do so, attach the following notices to the program. It is safest to attach them to the start of each source file to most effectively convey the exclusion of warranty; and each file should have at least the „copyright“ line and a pointer to where the full notice is found.

<one line to give the program's name and a brief idea of what it does>

Copyright (C) <year> <name of author>

This program is free software; you can redistribute it and/or modify it under the terms of the GNU General Public License

as published by the Free Software Foundation; either version 2 of the License, or (at your option) any later version.

This program is distributed in the hope that it will be useful, but WITHOUT ANY WARRANTY; without even the implied warranty of MERCHANTABILITY or FITNESS FOR A PARTICULAR PURPOSE. See the GNU General Public License for more details.

You should have received a copy of the GNU General Public License along with this program; if not, write to the Free Software Foundation, Inc., 59 Temple Place, Suite 330, Boston, MA 02111-1307 USA

#### IV.

Den vollständigen korrespondierenden Sourcecode der Software schickt Ihnen die snom technology AG auf Nachfrage gerne auf einem üblichen Datenträger gegen Erstattung der Herstellungskosten in Höhe von EUR 5,- zu.

Der vollständige korrespondierende Sourcecode kann auch über unsere Website unter [http://www.snom.com/gpl\\_.html?&L=0](http://www.snom.com/gpl_.html?&L=0) herunter geladen werden.

If requested by you, the complete corresponding source code of the Software can be sent by snom technology AG on a standard data storage medium against the reimbursement of the manufacturing costs of EUR 5.- per unit.

The complete corresponding source code of the Software can also be downloaded from our web site [http://www.snom.com/gpl\\_.html?&L=0](http://www.snom.com/gpl_.html?&L=0).

#### V.

Weitere Informationen finden Sie auch unter <http://www.snom.com>.

For further information see <http://www.snom.com>.



snom technology AG  
Charlottenstr. 68-71  
10117 Berlin, Deutschland  
Tel. +49 30 39 83 3-0  
Fax +49 30 39 83 31 11  
info@snom.com, sales@snom.com

snom France SARL  
6 Parc des fontenelles  
78870 Bailly, France  
Tel. +33 1 80 87 62 87  
Fax +33 1 80 87 62 88  
info@snom.com, sales@snom.com

snom technology, Inc.  
18 Commerce Way, Suite 6000  
Woburn, MA 01801, USA  
Tel. 781-569-2044  
Fax 978-998-7883  
infoUSA@snom.com

snom technology SRL  
Via A. Lusardi 10  
20122 Milano, Italia  
Tel +39 02 00611212  
Fax +39 02 93661864  
info@snom.com, sales@snom.com

snom UK Ltd  
Aspect Court  
47 Park Square East  
Leeds, LS12NL, UK  
Tel. +44 1133 503 111  
Fax +44 1133 503 110  
uksales@snom.com, info@snom.com

snom technology Ltd.  
Rm. A2, 3F, No. 37, Ln. 258  
Ruiguang Rd., Neihu Dist.  
Taipei City 114, Taiwan  
Tel +886-2-8751-1120  
Fax +886-2-8751-1130  
infoASIA@snom.com

Your specialist retailer - Ihr Fachhändler -  
Votre distributeur - Su distribuidor - Il tuo rivenditore:

